

MEASURING INSTRUMENTS - STRUMENTI PER MISURARE

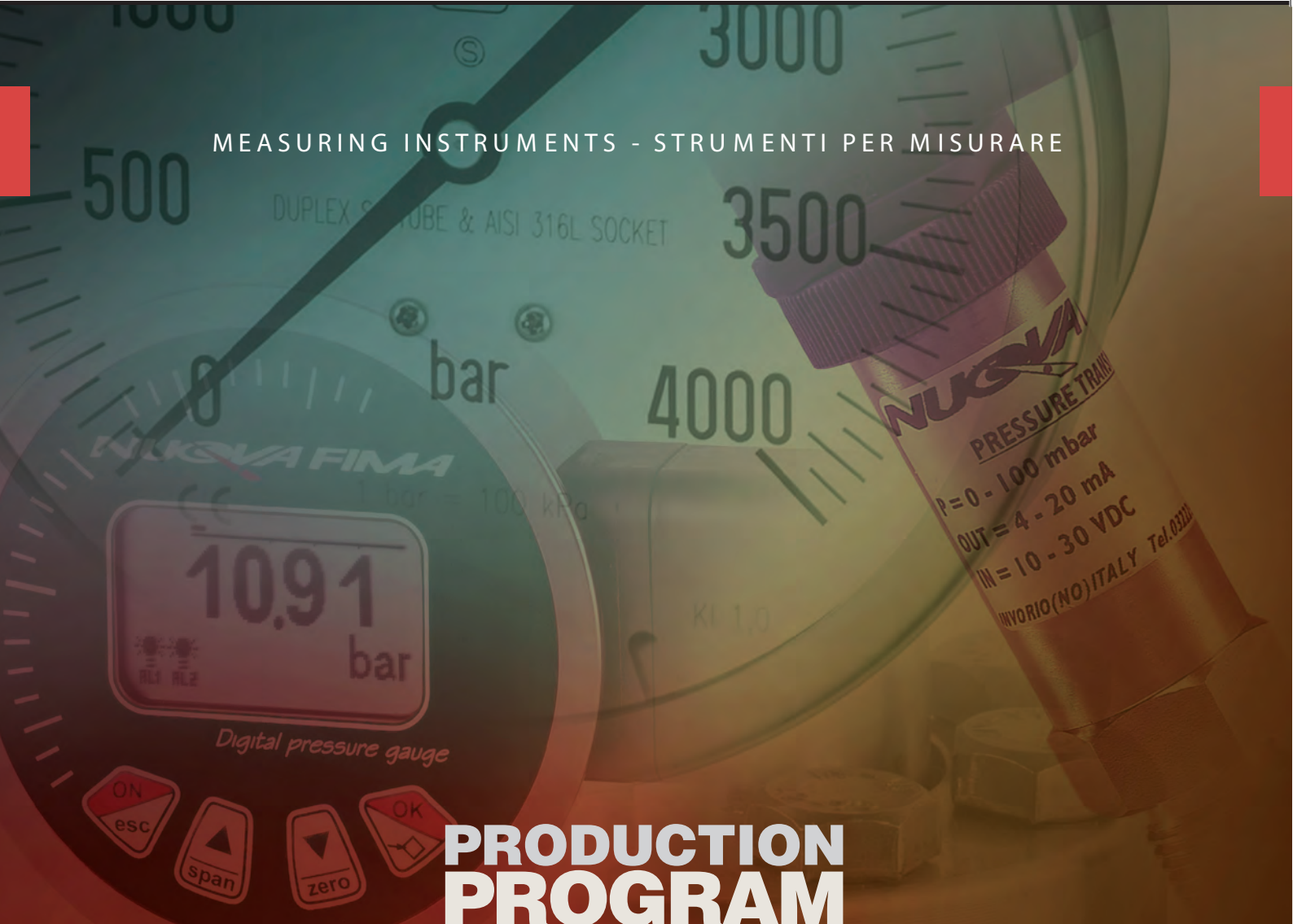

# PRODUCTION PROGRAM

PROGRAMMA  
DI PRODUZIONE

**NUOVA FIMA**

## CONTENTS

pag. / page 2

4	<b>Electronic Pressure Transmitters</b> <i>TRASMETTITORI elettronici di pressione</i>
6	<b>All Stainless Steel Pressure Gauges</b> <i>MANOMETRI in AISI 316 L</i>
8	<b>Copper alloy Pressure Gauges</b> <i>MANOMETRI in lega di rame</i>
10	<b>Instruments with electric and electronic contacts</b> <i>STRUMENTI con contatti elettrici ed elettronici</i>
11	<b>Laboratory Pressure Gauges</b> <i>MANOMETRI da laboratorio</i>
12	<b>Instruments for chemical and petrochemical industry</b> <i>STRUMENTI per l'industria chimica e petrolchimica</i>
14	<b>Food industry Instruments</b> <i>STRUMENTI per l'industria alimentare</i>
16	<b>Differential Pressure Gauges</b> <i>MANOMETRI differenziali</i>
17	<b>Low-Pressure Gauges</b> <i>MANOMETRI per basse pressioni</i>
18	<b>High-Pressure Gauges</b> <i>MANOMETRI per alte pressioni</i>
20	<b>Pressure Switches</b> <i>PRESSOSTATI</i>
22	<b>Diaphragm Seals</b> <i>SEPARATORI DI FLUIDO</i>
24	<b>Valves and Accessories</b> <i>VALVOLE ED ACCESSORI</i>
26	<b>Thermometers</b> <i>TERMOMETRI</i>
28	<b>Thermowells</b> <i>POZZETTI TERMOMETRICI</i>
	<b>Thermocouples and Resistance Temperature Detectors</b> <i>TERMOCOPPIE e TERMORESISTENZE</i>



## DIGITAL MULTIFUNCTIONAL

A piezoresistive sensor supplies a stable pressure signal which is processed through a microprocessor with high accuracy. The high graphic resolution display shows many functions such as the range adjustment up to 1:5, the peak values and temperature measurements, the choice for the unit of measurement and the language choice. Moreover two alarm signals are available through the configurable thresholds. In this way one single instrument is able to perform as a pressure gauge, as a pressure electronic transmitter and as a pressure switch.

## STRUMENTI DIGITALI MULTIFUNZIONE

Un sensore piezoresistivo fornisce uno stabile segnale di pressione che viene elaborato con alta precisione da un microprocessore. La regolazione del campo fino a 1:5, la misura dei valori di picco e di temperatura, la scelta dell'unità ingegneristica e della lingua sono alcune delle funzioni visualizzabili sullo schermo ad alta risoluzione grafica. Le soglie configurabili rendono poi disponibili anche due segnali di allarme. Vengono così realizzate le funzioni di manometro, trasmettitore elettronico di pressione e di pressostato, in un unico strumento.



SDM 18

Due to its exceptional properties, Sulphur Hexafluoride (SF6) is used mainly as an electrical insulator for sectioning devices, switched, and high voltage transformers. However, the operating safety of these devices depends on the density of the gas, which normal pressure and temperature measuring instruments are not able to monitor. Nuova Fima has designed specific electronic instruments fitted with microprocessors that use suitable software in order to accurately monitor the density of the SF6 gas.

Grazie alle sue eccezionali proprietà, l'Esafluoruro di Zolfo (SF6) è utilizzato principalmente come isolante elettrico su sezionatori, interruttori e trasformatori ad alta tensione. La sicurezza funzionale di questi sistemi dipende però dalla densità del gas che i normali strumenti di misurazione della pressione e temperatura non sono in grado di monitorare. Nuova Fima ha progettato specifici strumenti elettronici equipaggiati con un microprocessore, che usa un software adatto a monitorare accuratamente la densità del gas SF6.



ST SF6



ST 18 - SX 18  
ST 09 - SX 09



MT 18 DS4" - MX 18 DS4"  
MT 18 DN100 - MX 18 DN100



ST LV - SX LV



ST1 - ST2



ST MA - SX MA

**INTRINSIC SAFETY** - During regular working and in case of failures, any spark or temperature increase could occur and cause any explosive atmosphere blast. In order to reach this security level, the Nuova Fima intrinsically safe transmitters are built in conformity with the directive Atex 94/9/CE and normative EN 60079-0, EN 60079-11, EN 61241-0 and EN 61241-11. The Official Body CESI of Milan certified the homologation, Ex ia IIC T6 and Ex ia IIIC T85°C.

**SICUREZZA INTRINSECA** - Durante il funzionamento normale e nell'occorrenza di guasti, anche multipli, nessuna scintilla o incremento di temperatura possono manifestarsi e causare l'accensione dell'atmosfera esplosiva. Per raggiungere questo grado di protezione, i trasmettitori a sicurezza intrinseca NUOVA FIMA, sono costruiti in conformità alle prescrizioni della direttiva ATEX 94/9/CE e delle normative EN 60079-0, EN 60079-11, EN 61241-0 e EN 61241-11. L'Organismo Notificato CESI di Milano, ha certificato l'ottenimento delle omologazioni Ex ia IIC T6 e Ex ia D20 85°C.

Model - Modello	ST1	ST2	SDM 18	STSF6
<b>Measuring element</b> <i>Principio di misura</i>	ceramic sensor <i>sensore ceramico</i>	piezoresistive sensor <i>sensore piezoresistivo</i>	piezoresistive sensor <i>sensore piezoresistivo</i>	ceramic sensor <i>sensore ceramico</i>
<b>Ranges</b> <i>Campi scala</i>	0...15/0...9000 psi 0...1/0...600 bar	0...1,5/0...900 psi 0...0,1/0...60 bar	0...6/0...23000 psi 0...0,4/0...1600 bar	0...10/0...80 gr/liters 0...1,6/0...11,33 bar ABS
<b>Accuracy</b> <i>Classe di precisione</i>	≤ ± 1,0% of range ≤ ± 1,0% del campo	≤ ± 1,0% of range ≤ ± 1,0% del campo	≥ 0,1% of range ≥ 0,1% del campo	± 3% of range ± 3% del campo
<b>Protection degree</b> <i>Grado di protezione</i>	IP 65	IP 65	IP 65	IP 67
<b>Power supply</b> <i>Tensione di alimentazione</i>	up to: 8...30 Vdc <i>fino a: 8...30 Vcc</i>	up to: 8...30 Vdc <i>fino a: 8...30 Vcc</i>	10...30 Vdc <i>10...30 Vcc</i>	10...30 Vdc <i>10...30 Vcc</i>
<b>Output signals</b> <i>Segnali di uscita</i>	4...20 mA - 0...5/0...10 V 4...20 mA - 0...5/0...10 V	4...20 mA - 0...5/0...10 V 4...20 mA - 0...5/0...10 V	4...20 mA (3 wires) 4...20 mA (3 fili)	4...20 mA
<b>Mounting</b> <i>Tipi di montaggio</i>				
<b>Main features</b> <i>Principali caratteristiche</i>	<ul style="list-style-type: none"> <li>• General use</li> <li>• <i>Impiego generico</i></li> </ul>	<ul style="list-style-type: none"> <li>• Low pressure</li> <li>• <i>Bassa pressione</i></li> </ul>	<ul style="list-style-type: none"> <li>• Pressure gauge</li> <li>• Pressure transmitter</li> <li>• Pressure switch</li> <li>• <i>Manometro</i></li> <li>• <i>Trasmittitore di pressione</i></li> <li>• <i>Pressostato</i></li> </ul>	<ul style="list-style-type: none"> <li>• SF6 gas density transmitter</li> <li>• <i>Trasmittitore di densità del gas SF6</i></li> </ul>

Model - Modello (1)	MX18 DS4" MX18 DN100	SX 18	SX 09	SX LV	SX MA
<b>ATEX category</b> <i>Categoria ATEX</i>	1/2GD	1GD, 1/2GD	1GD, 1/2GD	1G	1GD, 1/2GD
<b>Measuring element</b> <i>Principio di misura</i>	bourdon tube and ceramic or AISI316 st. thin film sensor <i>molla tubolare e sensore ceramico o in AISI a film sottile</i>	ceramic sensor <i>sensore ceramico</i>	piezoresistive sensor <i>sensore piezoresistivo</i>	ceramic or piezoresistive sensor <i>sensore ceramico o piezoresistivo</i>	ceramic or piezoresistive sensor <i>sensore ceramico o piezoresistivo</i>
<b>Ranges</b> <i>Campi scala</i>	0...15/0...20000 psi 0...1/0...1600 bar	0...15/0...1000 psi 0...1/0...600 bar	0...40 INWC/0...870 psi 0...0,1/0...60 bar	0...40 INWC/0...400 psi 0...0,1/0...25 bar	0...15/0...1000 psi 0...1/0...600 bar
<b>Accuracy</b> <i>Classe di precisione</i>	0,5% of FSV <i>0,5% del VFS</i>	≥ 0,25% of range ≥ 0,25% del campo	≥ 0,25% of range ≥ 0,25% del campo	≥ 0,25% of range ≥ 0,25% del campo	≥ 0,5% of range ≥ 0,5% del campo
<b>Protection degree</b> <i>Grado di protezione</i>	IP 55...65	IP 65...68	IP 65	can be immersed <i>immersibile</i>	IP 65...68
<b>Power supply</b> <i>Tensione di alimentazione</i>	8...30 Vdc <i>8...30 Vcc</i>	8...30 Vdc <i>8...30 Vcc</i>	8...30 Vdc <i>8...30 Vcc</i>	8...30 Vdc <i>8...30 Vcc</i>	8...30 Vdc <i>8...30 Vcc</i>
<b>Output signals</b> <i>Segnali di uscita</i>	4...20 mA	4...20 mA	4...20 mA	4...20 mA	4...20 mA
<b>Mounting</b> <i>Tipi di montaggio</i>					
<b>Main features</b> <i>Principali caratteristiche</i>	<ul style="list-style-type: none"> <li>• Intrinsic safety Ex ia IIC T6</li> <li>• Ex ia IIIC T85°C</li> <li>• Independent sensor and elastic element</li> <li>• <i>Sicurezza intrinseca Ex ia IIC T6 Ex ia IIIC T85°C</i></li> <li>• <i>Sensore ed elemento elastico indipendenti</i></li> </ul>	<ul style="list-style-type: none"> <li>• Intrinsic safety Ex ia IIC T6 - Ex ia IIIC T85°C</li> <li>• <i>Sicurezza intrinseca Ex ia IIC T6 Ex ia IIIC T85°C</i></li> </ul>	<ul style="list-style-type: none"> <li>• Intrinsic safety Ex ia IIC T6 - Ex ia IIIC T85°C</li> <li>• <i>Sicurezza intrinseca Ex ia IIC T6 Ex ia IIIC T85°C</i></li> </ul>	<ul style="list-style-type: none"> <li>• Intrinsic safety Ex ia IIC T6 - Ex ia IIIC T85°C</li> <li>• Level sensor</li> <li>• <i>Sicurezza intrinseca Ex ia IIC T6 Ex ia IIIC T85°C</i></li> <li>• <i>Sensori di livello</i></li> </ul>	<ul style="list-style-type: none"> <li>• Intrinsic safety Ex ia IIC T6 - Ex ia IIIC T85°C</li> <li>• Faced diaphragm sensor</li> <li>• <i>Sicurezza intrinseca Ex ia IIC T6 Ex ia IIIC T85°C</i></li> <li>• <i>Membrana affacciata</i></li> </ul>

(1) the output signals in the instruments which are not ATEX certificated, include 0...5 V and 0...10 V as well  
(1) per le versioni non-ATEX sono disponibili anche i segnali di uscita 0...5 V e 0...10 V



# All stainless steel pressure gauges

# Manometri in AISI 316 L

## PRESSURE GAUGES FOR HIGH OVERPRESSURES

From now on, there is no need to mount expensive and bulky accessories on pressure gauges in order to be able to use them in the presence of high pressure peaks. Nuova Fima has developed the instruments of the Heavy Work series: MGS19 and MGS21, which feature a special technology of construction enabling them to meet the heaviest working conditions.

- They can be submitted to temporary overpressures four times the full scale value, without changes in precision and linearity.
- They can work at 100% of the full scale value with static pressures and at 90% with pulsating pressures.
- They fully comply with the safety normatives of the EN837.1 standards.
- They are both available in DS4" and 150.
- They can be filled with liquid, glycerine or other products, to improve the reading stability when they are used in presence of vibrations.

## MANOMETRI PER ALTE SOVRAPRESSIONI

Da oggi non è più necessario montare sui manometri, costosi e ingombranti accessori, per consentirne l'impiego in presenza d'elevati picchi di pressioni. Nuova Fima ha sviluppato gli strumenti della serie Heavy Work: MGS19 e MGS21, che racchiudono in sé una particolare tecnologia di costruzione che li rende in grado di soddisfare le condizioni di processo più gravose.

- Sono in grado di sopportare temporanee sovrappressioni fino a 4 volte il valore di fondo scala, senza che si alterino le caratteristiche di precisione e linearità.
- Possono lavorare al 100% del valore di fondo scala con pressioni statiche e 90% con pressioni pulsanti.
- Sono già conformi alle prescrizioni di sicurezza delle norme EN837.1.
- Sono entrambi disponibili nel DN100 e 150.
- Possono essere riempiti di liquido, glicerina o altro, per migliorarne la lettura quando l'impiego è in presenza di vibrazioni.



### RELIABILITY

Rugged construction to guarantee reliability even under extreme operating conditions. Excellent vibration resistance enhanced with the shape of the Bourdon tube inserted and welded in the socket. Excellent traceability assisted by the identification of each elastic element with the corresponding range, the Nuova Fima logo and the production batch number.

### AFFIDABILITÀ



### SAFETY

The Solid-Front execution, in compliance with the "S3" safety methods of the EN837.1/2 standards, is provided with a solid wall placed in front of the pressure gauge and a blow out device in the back, which, in case of accidental leaks or rupture of the elastic element, protect the operator in the immediate surroundings.

### SICUREZZA

L'esecuzione Solid-Front, in conformità a quanto prescritto dai criteri di sicurezza "S3" delle norme EN837.1/2, è dotata di una solida parete posta verso il fronte del manometro e un fondo dirompente verso il retro che, in caso di accidentali perdite o rotture dell'elemento elastico, proteggono l'operatore che si trova nelle immediate vicinanze.



MGS21 DS4"



MGS18 DS1.5"



MGS18 DS2"  
MGS18 DN50



MGS18 DS2.5"  
MGS18 DN63



MGS18 DS4-6"  
MGS18 DN100-150



MGS44 DS4"  
MGS44 DN100



MGS19 DS6"



MGS20 DS2,5"  
MGS20 DN63



MGS20 DS4"



MGS20 DS6"



MGS30 DS4.5"  
MGS30 DN125



MGS30 EXTRA DS4.5"  
MGS30 EXTRA DN125



MGS8 DS10"

Model - Modello	MGS18 DS1.5"-2" MGS18 DN40-50	MGS18 DS2.5" MGS18 DN63	MGS18 DS4"-6" MGS18 DN100-150	MGS19 DS4"-6" MGS19 DN100-150	MGS20 DS2.5" MGS20 DN63
ATEX category Categoria ATEX			2GD	2GD	
Ranges Campi scala	0...30/0...600 psi 0...2,5/0...40 bar	0...15/0...15000 psi ... and vacuum 0...1/0...1000 bar e vuoto	0...15/0...30000 psi ... and vacuum 0...0,6/0...1600 bar e vuoto	0...15/0...15000 psi ... and vacuum 0...1/0...1000 bar e vuoto	0...15/0...15000 psi ... and vacuum 0...1/0...1000 bar e vuoto
Working pressure (referred to f.s.v.) Pressione di esercizio (riferita al v.f.s.)	max 75%	max 75%	max 100%	max 100%	max 75%
Accuracy (as per EN 837-1) Classe di precisione (secondo EN 837-1)	1,6	1,6	0,6...1,0	1,0	1,6
Protection degree Grado di protezione	IP 55...67	IP 55...67	IP 55...67	IP 55...67	IP 55...67
Mounting Tipi di montaggio					
Main features Principali caratteristiche	<ul style="list-style-type: none"> <li>• Can be filled with dampening liquid</li> <li>• Possibilità di riempimento di fluido ammortizzante</li> </ul>	<ul style="list-style-type: none"> <li>• Can be filled with dampening liquid</li> <li>• Possibilità di riempimento di fluido ammortizzante</li> </ul>	<ul style="list-style-type: none"> <li>• Can be filled with dampening liquid</li> <li>• Complies with EN837-1</li> <li>• ATEX constructional safety type "C"</li> <li>• Possibilità di riempimento di fluido ammortizzante</li> <li>• Conforme alla norma EN837-1</li> <li>• Sicurezza costruttiva ATEX tipo "C"</li> </ul>	<ul style="list-style-type: none"> <li>• Overpressure up to 4 times the full scale value</li> <li>• Complies with EN837-1</li> <li>• ATEX constructional safety type "C"</li> <li>• Sovrappressione fino a 4 volte il valore di fondo scala</li> <li>• Conforme alla norma EN837-1</li> <li>• Sicurezza costruttiva ATEX tipo "C"</li> </ul>	<ul style="list-style-type: none"> <li>• Can be filled with dampening liquid</li> <li>• Complies with EN837-1</li> <li>• Solid-Front execution</li> <li>• Riempibile con liquido ammortizzante</li> <li>• Conforme alla norma EN837-1</li> <li>• Esecuzione Solid-Front</li> </ul>

Model - Modello	MGS20 DS4"-6" MGS20 DN100-150	MGS21 DS4"-6" MGS21 DN100-150	MGS30 DS4.5" MGS30 DN125	MGS30 EXTRA DS4.5" MGS30 EXTRA DN125	MGS8 DS10" MGS8 DN250	MGS44 DS4" MGS44 DN100
ATEX category Categoria ATEX	2GD	2GD				2GD IIB
Ranges Campi scala	0...15/0...30000 psi ... and vacuum 0...0,6/0...1600 bar e vuoto	0...15/0...15000 psi ... and vacuum 0...1/0...1000 bar e vuoto	0...15/0...30000 psi ... and vacuum 0...15/0...30000 psi e vuoto	0...30/0...15000 psi ... and vacuum 0...30/0...15000 psi e vuoto	0...15/0...15000 psi 0...1/0...1000 bar	0...15/0...6000 psi 0...1/0...400 bar
Working pressure (referred to f.s.v.) Pressione di esercizio (riferita al v.f.s.)	max 100%	max 100%	max 100%	max 75%	max 100%	max 75%
Accuracy Classe di precisione	up to 0,6 as per EN837-1 fino a 0,6 secondo EN 837-1	1,0 as per EN837-1 1,0 secondo EN 837-1	up to 2A grade as per ASME B40.1 fino a grado 2A secondo ASME B40.1	2A grade as per ASME B40.1 grado 2A secondo ASME B40.1	up to 0,6 as per EN837-1 fino a 0,6 secondo EN 837-1	1,0 as per EN837-1 1,0 secondo EN 837-1
Protection degree Grado di protezione	IP 55...67	IP 55...67	IP 55...67	IP 55	IP 55	IP 67
Mounting Tipi di montaggio						
Main features Principali caratteristiche	<ul style="list-style-type: none"> <li>• ATEX constructional safety type "C"</li> <li>• Solid-Front execution</li> <li>• Can be filled with dampening liquid</li> <li>• Complies with EN837-1</li> <li>• Sicurezza costruttiva ATEX tipo "C"</li> <li>• Esecuzione Solid-Front</li> <li>• Riempibile di liquido ammortizzante</li> <li>• Conforme alla norma EN837-1</li> </ul>	<ul style="list-style-type: none"> <li>• ATEX constructional safety type "C"</li> <li>• Overpressure up to 4 times the full scale value</li> <li>• Solid-Front execution</li> <li>• Can be filled with dampening liquid</li> <li>• Complies with EN837-1</li> <li>• Sicurezza costruttiva ATEX tipo "C"</li> <li>• Sovrappressione fino a 4 volte il V.F.S.</li> <li>• Esecuzione Solid-Front</li> <li>• Riempibile di liquido ammortizzante</li> <li>• Conforme alla norma EN837-1</li> </ul>	<ul style="list-style-type: none"> <li>• Solid-front execution plastic turret case</li> <li>• Complies with ASME B40.1 standard</li> <li>• Can be filled with dampening liquid</li> <li>• Esecuzione Solid-Front cassa tronco conica in materiale plastico</li> <li>• Conforme alla norma ASME B40.1</li> <li>• Riempibile di liquido ammortizzante</li> </ul>	<ul style="list-style-type: none"> <li>• Solid-front execution plastic turret case</li> <li>• Dampened movement</li> <li>• Esecuzione Solid-Front cassa tronco conica in materiale plastico</li> <li>• Movimento ammortizzato</li> </ul>	<ul style="list-style-type: none"> <li>• Aluminium case</li> <li>• St.St. movement</li> <li>• AISI316L wetted parts</li> <li>• Cassa in alluminio</li> <li>• Movimento in acciaio</li> <li>• Parti bagnate in AISI316L</li> </ul>	<ul style="list-style-type: none"> <li>• Compact and economic model</li> <li>• Modello economico e compatto</li> </ul>

# Copper alloy pressure gauges

# Manometri in leghe di rame

They are designed for measuring pressure ranges from 0...15 to 0...15000 psi as well as negative pressures. They can be used with liquids or gasses that do not corrode the copper alloys, do not have a high viscosity and do not crystallise. The filling of the stainless steel case with damping liquid allows to use it also in the presence of vibrations or pulsating pressures.

*Sono progettati per la misura di pressioni comprese tra i campi scala 0...1 e 0...1000 bar nonché pressioni negative. Possono essere impiegati con fluidi liquidi o gassosi che non attaccano le leghe di rame, che non presentano una viscosità elevata e che non cristallizza. Il riempimento della custodia in acciaio inox con liquido ammortizzante ne consente l'installazione anche in presenza di vibrazioni o pressioni pulsanti.*

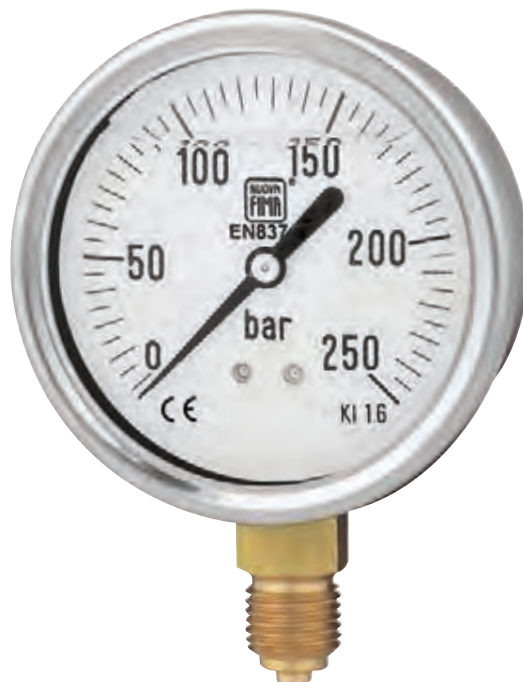

MGS10 DS2.5"  
MGS10 DN63



MS1 DS1.5"  
MS1 DN40



MS1 DS2"  
MS1 DN50



MS1 DS6"  
MS1 DN150



MS2 DS1.5"-2"-2.5"  
MS2 DN40-50-63



MS3 DS1.5"-2"-2.5"  
MS3 DN40-50-63



MS7 DS1.5"-2"-2.5"  
MS7 DN40-50-63



MS4 DS4"  
MS4 DN100



MGS10 DS2"  
MGS10 DN50



MGS10 DS4"  
MGS10 DN100

Model - Modello	MS1 DS1.5" MS1 DN40	MS1 DS2" MS1 DN50	MS1 DS6" MS1 DN150	MS2 DS1.5"-2"-2.5" MS2 DN40-50-63	MS3 DS1.5"-2"-2.5" MS3 DN40-50-63
Ranges Campi scala	0...30/0...600 psi 0...2,5/0...40 bar	0...30/0...6000 psi 0...2,5/0...400 bar	0...15/0...15000 psi ... and vacuum 0...1/0...1000 bar e vuoto	-30...0 In HG/0...600 psi -1...0/0...40 bar	-30...0 In HG/0...3000 psi -1...0/0...250 bar
Working pressure (referred to f.s.v.) Pressione di esercizio (riferita al v.f.s.)	max 75%	max 75%	max 75%	max 75%	max 75%
Accuracy (as per EN 837-1) Classe di precisione (secondo EN 837-1)	1,6	1,6	1,6	2,5	2,5
Protection degree Grado di protezione	IP 40	IP 40	IP 44		
Mounting Tipi di montaggio					
Main features Principali caratteristiche	<ul style="list-style-type: none"> <li>• St. st. case</li> <li>• Cassa in acciaio inox</li> </ul>	<ul style="list-style-type: none"> <li>• St. st. case</li> <li>• Cassa in acciaio inox</li> </ul>	<ul style="list-style-type: none"> <li>• St. st. case</li> <li>• Complies with the EN837-1 standard</li> <li>• Cassa inox</li> <li>• Conforme alla norma EN837-1</li> </ul>	<ul style="list-style-type: none"> <li>• ABS case</li> <li>• Cassa in ABS</li> </ul>	<ul style="list-style-type: none"> <li>• Painted steel case</li> <li>• Cassa in acciaio verniciata</li> </ul>

Model - Modello	MS7 DS1.5"-2"-2.5" MS7 DN40-50-63	MS4 DS4" MS4 DN100	MGS10 DS2" MGS10 DN50	MGS10 DS2.5" MGS10 DN63	MGS10 DS4" MGS10 DN100
Ranges Campi scala	-30...0 In HG/0...3000 psi -1...0/0...250 bar	0...15/0...15000 psi ... and vacuum 0...1/0...1000 bar e vuoto	0...30/0...6000 psi 0...2,5/0...400 bar	0...15/0...10000 psi ... and vacuum 0...1/0...600 bar e vuoto	0...15/0...15000 psi ... and vacuum 0...1/0...1000 bar e vuoto
Working pressure (referred to f.s.v.) Pressione di esercizio (riferita al v.f.s.)	max 75%	max 75%	max 75%	max 75%	max 100%
Accuracy (as per EN 837-1) Classe di precisione (secondo EN 837-1)	2,5	1,6	1,6	1,6	1,0
Protection degree Grado di protezione		IP 67	IP 67	IP 67	IP 55...IP 67
Mounting Tipi di montaggio					
Main features Principali caratteristiche	<ul style="list-style-type: none"> <li>• Painted steel case and ring</li> <li>• Cassa ed anello in acciaio verniciato</li> </ul>	<ul style="list-style-type: none"> <li>• St. st. case</li> <li>• Compact and economic model</li> <li>• Complies with the EN837-1 standard</li> <li>• Cassa inox</li> <li>• Versione compatta ed economica</li> <li>• Conforme alla norma EN837-1</li> </ul>	<ul style="list-style-type: none"> <li>• St. st. case</li> <li>• Can be filled with dampening liquid</li> <li>• Cassa inox</li> <li>• Possibilità di riempimento di fluido ammortizzante</li> </ul>	<ul style="list-style-type: none"> <li>• St. st. case</li> <li>• Can be filled with dampening liquid</li> <li>• Cassa inox</li> <li>• Possibilità di riempimento di fluido ammortizzante</li> </ul>	<ul style="list-style-type: none"> <li>• St. st. case</li> <li>• Can be filled with dampening liquid</li> <li>• Complies with the EN837-1 standard</li> <li>• Cassa inox</li> <li>• Possibilità di riempimento di fluido ammortizzante</li> <li>• Conforme alla norma EN837-1</li> </ul>



## Instruments with electric and electronic contacts

## Strumenti con contatti elettrici ed elettronici

They are used to control the electrical operations on compressors, pumps, presses, hydraulic and pneumatics circuits, air-pressured circuits, chemical and petrochemical plants. The contacts open and close the circuit according to the position of the indicating pointer.

They are available: with SPDT microswitch; with single or double electric contacts; with single or double inductive contacts, intrinsically safe.

*Sono utilizzati per realizzare interventi elettrici su compressori, pompe, presse, circuiti oleodinamici, idraulici, pneumatici, impianti chimici e petrolchimici.*

*I contatti aprono e chiudono i circuiti in funzione della posizione della lancetta indicatrice. Sono disponibili: con microinterruttore SPDT; con contatti elettrici in aria, singoli o doppi; con contatti induttivi a sicurezza intrinseca, singoli o doppi.*



MCE18 DS4"  
MCE18 DN100

Due to its exceptional properties, Sulphur Hexafluoride (SF6) is used mainly as an electrical insulator for sectioning devices, switched, and high voltage transformers. However, the operating safety of these devices depends on the density of the gas, which normal pressure and temperature measuring instruments are not able to monitor. Nuova Fima has designed specific mechanical instruments that have electrical contacts that are able to activate an alarm signal, as soon as the density of the gas reduces their insulating capacity.

*Grazie alle sue eccezionali proprietà, l'Esaffluoruro di Zolfo (SF6) è utilizzato principalmente come isolante elettrico su sezionatori, interruttori e trasformatori ad alta tensione. La sicurezza funzionale di questi sistemi dipende però dalla densità del gas che i normali strumenti di misurazione della pressione e temperatura non sono in grado di monitorare. Nuova Fima ha progettato specifici strumenti meccanici dotati di contatti elettrici in grado di fornire un segnale di allarme allorché la densità del gas riduce la propria capacità isolante.*



MCE20 DS6"  
MCE20 DN150



TCE DS4"  
TCE DN 100



MGS72-74 DS4"  
MGS72-74 DN100



TM8 DS4"- 6"  
TM8 DN100-150



MCE10-18/SF6 DS4"  
MCE10-18/SF6 DN100



MN14/10-18 DS4"- 6"  
MN14/10-18 DN100-150

Model - Modello	MGS72 DS4" MGS72 DN100	MGS74 DS4" MGS74 DN100	MN14/10 DS4"-6" MN14/10 DN100-150	MN14/18 DS4"-6" MN14/18 DN100-150
<b>Wetted parts</b> <i>Materiale parti bagnate</i>	copper alloy or copper alloy / AISI316L <i>leghe di rame o leghe di rame / AISI316L</i>	AISI316L	copper alloy or copper alloy / AISI316L <i>leghe di rame o leghe di rame / AISI316L</i>	AISI316L
<b>Ranges</b> <i>Campi scala</i>	0...15/0...10000 psi and vacuum <i>0...1/0...600 bar e vuoto</i>	0...15/0...10000 psi and vacuum <i>0...1/0...600 bar e vuoto</i>	0...30/0...15000 psi <i>0...1,6/0...1000 bar</i>	0...15/0...20000 psi and vacuum <i>0...1/0...1600 bar e vuoto</i>
<b>Electric intervention</b> <i>Intervento elettrico</i>	SPDT microswitch <i>microinterruttore SPDT</i>	SPDT microswitch <i>microinterruttore SPDT</i>	sliding electrical contacts <i>contatti elettrici a sfioramento</i>	sliding electrical contacts <i>contatti elettrici a sfioramento</i>
<b>Accuracy</b> <i>Classe di precisione</i>	2,5	2,5	1,0	1,0
<b>Protection degree</b> <i>Grado di precisione</i>	IP 44	IP 44	IP 44..55	IP 44..55
<b>Mounting</b> <i>Tipi di montaggio</i>				

Model - Modello	MCE10 DS4" MCE10 DN100	MCE18 DS4" MCE18 DN100	MCE20 DS6" MCE20 DN150	MCE10/SF6 DS4" MCE10/SF6 DN100	MCE18/SF6 DS4" MCE18/SF6 DN100
<b>Measuring element</b> <i>Principio di misura</i>	copper alloy or copper alloy / AISI316L <i>leghe di rame o leghe di rame / AISI316L</i>	AISI316L	AISI316L	copper alloy or copper alloy / AISI316L <i>leghe di rame o leghe di rame / AISI316L</i>	AISI316L
<b>Ranges</b> <i>Campi scala</i>	0...15/0...15000 psi <i>0...1/0...1000 bar</i>	0...15/0...20000 psi and vacuum <i>0...1/0...1600 bar e vuoto</i>	0...15/0...20000 psi and vacuum <i>0...1/0...1600 bar e vuoto</i>	-1...+0,6/-1...+24 bar	-1...+0,6/-1...+24 bar
<b>Electric intervention</b> <i>Intervento elettrico</i>	built-in sliding electrical contacts <i>contatti elettrici a sfioramento, sottoquadrante</i>	built-in electrical contacts sliding or inductive <i>contatti elettrici e induttivi, sottoquadrante</i>	built-in sliding electrical contacts <i>contatti elettrici a sfioramento, sottoquadrante</i>	built-in sliding electrical contacts <i>contatti elettrici a sfioramento, sottoquadrante</i>	built-in sliding electrical contacts <i>contatti elettrici a sfioramento, sottoquadrante</i>
<b>Accuracy</b> <i>Classe di precisione</i>	1,6	1,6...1,0	1,6...1,0	1,0...2,5	1,0...2,5
<b>Protection degree</b> <i>Grado di precisione</i>	IP 55...67	IP 55...67	IP 55...67	IP 54...65	IP 54...65
<b>Mounting</b> <i>Tipi di montaggio</i>					
<b>Main features</b> <i>Principali caratteristiche</i>	<ul style="list-style-type: none"> <li>• Can be filled with dampening liquid</li> <li>• <i>Riempibile di liquido ammortizzante</i></li> </ul>	<ul style="list-style-type: none"> <li>• Can be filled with dampening liquid</li> <li>• <i>Riempibile di liquido ammortizzante</i></li> </ul>	<ul style="list-style-type: none"> <li>• Can be filled with dampening liquid</li> <li>• Solid-Front execution</li> <li>• <i>Riempibile di liquido ammortizzante</i></li> <li>• <i>Esecuzione Solid-Front</i></li> </ul>	<ul style="list-style-type: none"> <li>• SF6 gas density monitoring</li> <li>• <i>Monitoraggio densità gas SF6</i></li> </ul>	<ul style="list-style-type: none"> <li>• SF6 gas density monitoring</li> <li>• <i>Monitoraggio densità gas SF6</i></li> </ul>

Model - Modello	TM8 DS4"-6" TM8 DN100-150	TCE DS4" TCE DN100
<b>Wetted parts</b> <i>Materiale parti bagnate</i>	AISI316L	AISI316L
<b>Ranges</b> <i>Campi scala</i>	-350...+200/200...1200°F <i>-200...+100/100...600 °C</i>	-350...+200/200...1200°F <i>200...+100/100...600 °C</i>
<b>Electric intervention</b> <i>Intervento elettrico</i>	SPDT microswitch <i>microinterruttore SPDT</i>	built-in electrical contacts sliding or inductive <i>contatti elettrici e induttivi, sottoquadrante</i>
<b>Accuracy (as per EN 837-1)</b> <i>Classe di precisione</i>	2,5 as per EN13190-DIN16085 <i>2,5 secondo EN13190-DIN16085</i>	2,5 as per EN13190-DIN16085 <i>2,5 secondo EN13190-DIN16085</i>
<b>Protection degree</b> <i>Grado di precisione</i>	IP 44...55	IP 55...67
<b>Mounting</b> <i>Tipi di montaggio</i>		

# Laboratory pressure gauges

# Manometri da laboratorio

These instruments are designed to be used as test gauges and in other applications where precision and repeatability are very important features. They may be provided with a Nuova Fima calibration certificate as well as a calibration certificate issued by an authorised laboratory from S.I.T. (Servizio Italiano Taratura, Italian Calibration Service).

*Sono strumenti realizzati per essere impiegati come manometri di controllo o di ricalibrazione e in altre applicazioni dove la precisione e la ripetibilità sono elementi molto importanti.*

*Possono essere accompagnati, oltre che da un certificato di taratura Nuova Fima, anche da un certificato di taratura rilasciato da un laboratorio accreditato dal S.I.T. (Servizio Italiano Taratura)*



MN17/L DS10"  
MN17/L DN250



MN15 DS6"  
MN15 DN150



MN16 DS6"  
MN16 DN150



MN17 DS6"  
MN17 DN150



MN25 DS6"  
MN25 DN150



Model - Modello	MN15 DS6" MN15 DN150	MN16 DS6" MN16 DN150	MN17 DS6" MN17 DN150	MN25 DS6" MN25 DN150	MN17/L DS10" MN17/L DN250
Wetted parts Materiale parti bagnate	AISI316L	AISI316L	AISI316L / beryllium copper AISI316L / lega di rame al berillio	AISI316L	AISI316L / beryllium copper AISI316L / lega di rame al berillio
Ranges Campi scala	0...10/0...10000 psi and vacuum 0...0,6/0...600 bar e vuoto	0...10/0...10000 psi and vacuum 0...0,6/0...600 bar e vuoto	0...10/0...15000 psi and vacuum 0...0,6/0...1000 bar e vuoto	0...1/0...160 bar	0...15/0...20000 psi and vacuum 0...1/0...1600 bar e vuoto
Accuracy (as per EN 837-1) Classe di precisione (secondo EN 837-1)	0,6	0,6	0,25	0,25	0,1
Protection degree Grado di protezione	IP 55	IP 55	IP 55	IP 55	IP 44
Mounting Tipi di montaggio					
Main features Principali caratteristiche	<ul style="list-style-type: none"> <li>Complies with the EN837-1 standard</li> <li>Anti-parallax mirror dial</li> <li>Conforme alla norma EN837-1</li> <li>Quadrante con banda anti parallasse</li> </ul>	<ul style="list-style-type: none"> <li>Complies with the EN837-1 standard</li> <li>Solid-Front execution</li> <li>Anti-parallax mirror dial</li> <li>Conforme alla norma EN837-1</li> <li>Esecuzione Solid-Front</li> <li>Quadrante con banda anti parallasse</li> </ul>	<ul style="list-style-type: none"> <li>Complies with the EN837-1 standard</li> <li>Solid-Front execution</li> <li>Anti-parallax mirror dial</li> <li>Conforme alla norma EN837-1</li> <li>Esecuzione Solid-Front</li> <li>Quadrante con banda anti parallasse</li> </ul>	<ul style="list-style-type: none"> <li>Complies with the EN837-1 standard</li> <li>Solid-Front execution</li> <li>Anti-parallax mirror dial</li> <li>Conforme alla norma EN837-1</li> <li>Esecuzione Solid-Front</li> <li>Quadrante con banda anti parallasse</li> </ul>	<ul style="list-style-type: none"> <li>Aluminium case</li> <li>Anti-parallax mirror dial</li> <li>Cassa in alluminio</li> <li>Quadrante con banda anti parallasse</li> </ul>

# Instruments for chemical and petrochemical industry

# Strumenti per l'industria chimica e petrolchimica

## PRESSURE GAUGES FOR OIL REFINING AND EXTRACTION

These instruments are built to resist to the most severe working conditions in the atmosphere with H<sub>2</sub>S. They perform wetted parts in Monel 400, so they are in conformity with the two following Nace directives:

- NACE MR 01.03 issued for the refining sector and the process concerned connections;
- NACE MR 01.75 (ISO 15156) issued for the Sour Oilfield Environments sector with H<sub>2</sub>S which is oil extraction, oil transportation and oil stocking.

## ATEX VERSIONS

Nuova Fima is engaged in optimising a complete range of products built in conformity with the Health and Security features following the directive ATEX 94/9/CE regarding their use in chemical and petrochemical industry and where safe installations are a must against explosion risk even in case of malfunctioning.

## ESECUZIONI ATEX

NUOVA FIMA è impegnata ad approntare una gamma completa di prodotti costruiti secondo i requisiti di Salute e Sicurezza previsti dalla direttiva ATEX 94/9/CE, per l'utilizzo nell'industria chimica e petrolchimica e laddove esistono requisiti per installazioni sicure nei confronti dei rischi di esplosione, anche durante i malfunzionamenti.



Bourdon tube pressure gauge mod. MGS 18-19-20-21-36-40, intrinsically safe inductive contacts pressure

gauges mod. MCE, differential pressure gauge with double diaphragm mod. MD13-15-17, diaphragm pressure gauge mod. MN12, explosion-proof pressure switches 3.4 serie, bi-metal thermometers mod. TB8, inert gas thermometers mod. TG8, intrinsically safe sensors SX-MX series. These instruments concern the chemical and petrochemical industry.

Manometri a molla bourdon mod. MGS18-19-20-21-36 e 40, manometri con contatti induttivi a sicurezza intrinseca mod. MCE, manometri differenziali a doppia membrana mod. MD13-15-17, manometri a membrana mod. MN12, pressostati antideflagranti serie 3.4x, termometri bimetallici mod. TB8, termometri a gas inerte mod. TG8, e sensori a sicurezza intrinseca serie SX ed MX, sono gli strumenti dedicati all'industria chimica e petrolchimica.

## MANOMETRI PER ESTRAZIONE E RAFFINAZIONE

Questi strumenti sono progettati per resistere alle più critiche condizioni operative presenti nelle atmosfere con H<sub>2</sub>S, disponendo di parti bagnate in MONEL 400, e sono così conformi alle due principali norme NACE:

- NACE MR 01.03, che è stata emessa per coprire il settore della raffinazione e delle relative connessioni al processo;
- NACE MR 01.75 (ISO15156) che regola il settore Sour Oilfield Environments con presenza di H<sub>2</sub>S e cioè estrazione, trasporto e stoccaggio di petrolio.

## DIAPHRAGM SEALS

The fluid diaphragm seals MGS/5 and MGS9/3B built with special materials are especially designed for the chemical and petrochemical industry satisfying any pressure, temperature and process connections dimensions demand.



## SEPARATORI DI FLUIDO

I separatori di fluido MGS9/5 e MGS9/3B in materiali speciali sono costruiti espressamente per l'industria chimica e petrolchimica, di cui soddisfano tutte le esigenze di pressioni, temperature e dimensioni degli attacchi al processo.

As for the Urea contact versions the MGS9/SA459-460 pressure switches are available. They are built strictly following the anticorrosion criteria and they become well-known all over the world for their reliability and high level performance developed during the years.

Per le applicazioni a contatto con UREA sono disponibili i separatori MGS9/SA459-460, costruiti secondo stringenti criteri anticorrosione, evolutisi negli anni fino a divenire una realtà riconosciuta a livello mondiale per affidabilità e alte prestazioni.



MGS40 DS4"-6"  
MGS40 DN100-150



MGS36 DS4"-6"  
MGS36 DN100-150



MGS60 DS4.5"  
MGS60 DN125



Model - Modello	MGS36 DS4"-6" MGS36 DN100-150	MGS40 DS4"-6" MGS40 DN100-150	MGS60 DS4.5" MGS60 DN125
ATEX category Categoria ATEX	2GD	2GD	
Wetted parts Materiale parti bagnate	Monel 400	Monel 400	Monel 400
Ranges Campi scala	0...15/0...10000 psi and vacuum 0...1/0...600 bar e vuoto	0...15/0...10000 psi and vacuum 0...1/0...600 bar e vuoto	0...15/0...10000 psi and vacuum 0...1/0...600 bar e vuoto
Accuracy Classe di precisione	1,0 as per EN837-1 1,0 secondo EN837-1	1,0 as per EN837-1 1,0 secondo EN837-1	1A grade as per ASME B40.1 Grado 1A secondo ASME B40.1
Protection degree Grado di protezione	IP 55...67	IP 55...67	IP 55...67
Mounting Tipi di montaggio			
Main features Principali caratteristiche	<ul style="list-style-type: none"> <li>• ATEX constructional safety type "C"</li> <li>• Sicurezza costruttiva ATEX tipo "C"</li> </ul>	<ul style="list-style-type: none"> <li>• ATEX constructional safety type "C"</li> <li>• Solid-Front execution</li> <li>• Sicurezza costruttiva ATEX tipo "C"</li> <li>• Esecuzione Solid-Front</li> </ul>	<ul style="list-style-type: none"> <li>• Solid-Front execution</li> <li>• Plastic turret case</li> <li>• Esecuzione Solid-Front</li> <li>• Cassa tronco conica in materiale plastico</li> </ul>



They are designed to be used in sanitary applications, food and pharmaceutical industries in compliance with 74-05 standards of the 3A association (Sanitary Standards Symbol Administrative Council). The absence of interstices and the mirror finishing of the components ensure the best hygiene. The process connection consists in a diaphragm seal, integrally mounted on the pressure gauge.

*Sono realizzati per l'utilizzo in impianti sanitari, alimentari e farmaceutici in conformità alle normative 74-05 dell'associazione 3A (Sanitary Standards Symbol Administrative Council). L'assenza di interstizi e la lucidatura elettrolitica dei componenti ne garantiscono la massima igiene. L'attacco al processo è costituito da un separatore di fluido a membrana, parte integrante del manometro.*



**74-05**

**Authorization** NO. 1599

*Autorizzazione* NO. 1599



SP DS4"  
SP DN100



OM DS4"  
OM DN100



SP DS2.5"  
SP DN63



MT OM DS4" - MX OM DS4"  
MT OM DN100 - MX OM DN100



ST SA - SX SA

Model - Modello	OM DS4" OM DN100	SP DS2.5" SP DN63	SP DS4" SP DN100
ATEX category Categoria ATEX	2GD		
Wetted parts Materiale parti bagnate	AISI316L	AISI316L	AISI316L
Ranges Campi scala	0...2000/0...15000 psi 0...160/0...1600 bar	0...15/0...600 psi	0...15/0...600 psi
Accuracy Classe di precisione	1,6	1,6	1,6
Protection degree Grado di protezione	IP 65	IP 65	IP 65
Mounting Tipi di montaggio			
Main features Principali caratteristiche	<ul style="list-style-type: none"> <li>• ATEX constructional safety type "C"</li> <li>• Used on homogenizers</li> <li>• Sicurezza costruttiva ATEX tipo "C"</li> <li>• Impiego su omogeneizzatori</li> </ul>	<ul style="list-style-type: none"> <li>• ISO 2852 process connection: 1"1/2; 2"</li> <li>• Attacchi al processo: 1"1/2; 2" secondo ISO 2852</li> </ul>	<ul style="list-style-type: none"> <li>• ISO 2852 process connection: 1"1/2; 2"</li> <li>• Attacchi al processo: 1"1/2; 2" secondo ISO 2852</li> </ul>

Model - Modello	MT OM DS4" MT OM DN100	ST SA	MX OM DS4" MX OM DN100	SX SA
ATEX category Categoria ATEX			1GD, 1/2GD	1GD, 1/2GD
Measuring element Principio di misura	bourdon tube and ceramic or AISI316 st. st. thin film sensor molla tubolare e sensore ceramico o in AISI a film sottile	ceramic or piezoresistive sensor sensore ceramico o piezoresistivo	bourdon tube and ceramic or AISI316 st. st. thin film sensor molla tubolare e sensore ceramico o in AISI a film sottile	ceramic or piezoresistive sensor sensore ceramico o piezoresistivo
Ranges Campi scala	0...1500/0...20000 psi 0...100/0...1600 bar	0...10/0...600 psi 0...0,6/0...40 bar	0...1500/0...20000 psi 0...100/0...1600 bar	0...10/0...600 psi 0...0,6/0...40 bar
Accuracy Classe di precisione	1,0% of FSV 1,0% del VFS	≥ 0,5% of range ≥ 0,5% del campo	1,0% of FSV 1,0% del VFS	≥ 0,5% of range ≥ 0,5% del campo
Protection degree Grado di protezione	IP 65	IP 65...68	IP 65	IP 65...68
Power supply Tensione di alimentazione	up to: 8...30 Vdc fino a: 8...30 Vcc	up to: 8...30 Vdc fino a: 8...30 Vcc	8...30 Vdc 8...30 Vcc	8...30 Vdc 8...30 Vcc
Output signals Segnali di uscita	4...20 mA 0...5/0...10 V	4...20 mA 0...5/0...10 V	4...20 mA	4...20 mA
Mounting Tipi di montaggio				
Main features Principali caratteristiche	<ul style="list-style-type: none"> <li>• Independent sensor and elastic element</li> <li>• Can be filled with dampening liquid</li> <li>• Sensore ed elemento elastico indipendenti</li> <li>• Riempibile di liquido ammortizzante</li> </ul>	<ul style="list-style-type: none"> <li>• Process connections as per DIN 11851, SMS and ISO 2852</li> <li>• Attacchi al processo secondo DIN 11851, SMS ed ISO 2852</li> </ul>	<ul style="list-style-type: none"> <li>• Intrinsic safety Ex ia IIC T6 - Ex ia IIIC T85°C</li> <li>• Independent sensor and elastic element</li> <li>• Can be filled with dampening liquid</li> <li>• Sicurezza intrinseca Ex ia IIC T6 Ex ia IIIC T85°C</li> <li>• Sensore ed elemento elastico indipendenti</li> <li>• Riempibile di liquido ammortizzante</li> </ul>	<ul style="list-style-type: none"> <li>• Intrinsic safety Ex ia IIC T6 - Ex ia IIIC T85°C</li> <li>• Process connections as per DIN 11851, SMS and ISO 2852</li> <li>• Sicurezza intrinseca Ex ia IIC T6 Ex ia IIIC T85°C</li> <li>• Attacchi al processo secondo DIN 11851, SMS ed ISO 2852</li> </ul>

# Differential pressure gauges

# Manometri differenziali

These instruments are used to check differential pressures of gaseous liquids which do not have high viscosity and do not crystallize. In presence of high temperature, high viscosity and corrosive process fluid or which can crystallize these instruments can be fitted with remote mounting diaphragm seals. They are mainly used to measure liquids level contained in pressurized tanks, big filters obstructions and fluids velocity inside pipes.

*Strumenti adatti per l'indicazione di pressioni differenziali di fluidi gassosi o liquidi che non presentano una viscosità elevata e che non cristallizzano. Possono essere corredati di separatori in presenza di fluidi di processo corrosivi, ad alta temperatura, a viscosità elevata o cristallizzabili. Sono impiegati principalmente per la misura di livello di liquidi in serbatoi pressurizzati, per la misura di intasamento di grossi filtri, per la misura di velocità di fluidi all'interno di tubazioni.*



MD15 DS4"-6"  
MD15 DN100-150

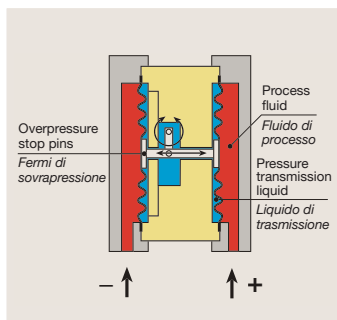

## DIFFERENTIAL PRESSURE GAUGES

The double diaphragm measuring cell is characterised by a system of limitstops that closes and blocks the passage obtaining in this way a liquid bed on which stop the measuring element in case of one-side overpressure.

## MANOMETRI DIFFERENZIALI

*La cella di misura a doppia membrana è caratterizzata da un sistema di fermi che, in caso di sovrappressione unilaterale, chiudono e bloccano il passaggio ottenendo così un letto liquido su cui si adegua l'elemento di misura.*



MD14 DS4"-6"  
MD14 DN100-150



MD16 DS4"-6"  
MD16 DN100-150



MD17 DS4"-6"  
MD17 DN100-150



MD18 DS4"-6"  
MD18 DN100-150

Model - Modello	MD13 DS6" MD13 DN150	MD14 DS6" MD14 DN150	MD15 DS4"-6" MD15 DN100-150	MD16 DS4"-6" MD16 DN100-150	MD17 DS4"-6" MD17 DN100-150	MD18 DS4" MD18 DN100
<b>ATEX category</b> <i>Categoria ATEX</i>	2GD		2GD	2GD	2GD	
<b>Measuring element</b> <i>Principio di misura</i>	diaphragm <i>membrana</i>	bellows <i>soffietto</i>	double diaphragm <i>doppia membrana</i>	double diaphragm <i>doppia membrana</i>	double diaphragm <i>doppia membrana</i>	double Bourdon tube <i>doppia molla tubolare</i>
<b>Wetted parts</b> <i>Materiale parti bagnate</i>	AISI316L	AISI316L	AISI316L or Monel 400 <i>AISI316L o Monel 400</i>	AISI316L or Monel 400 <i>AISI316L o Monel 400</i>	AISI316L or Monel 400 <i>AISI316L o Monel 400</i>	AISI316L
<b>Ranges</b> <i>Campi scala</i>	0...0,6/0...25 bar	0...10/0...160 mbar	0...4/0...300 psi <i>0...0,1/0...25 bar</i>	0...6/0...160 psi <i>0...0,4/0...10 bar</i>	0...15/0...160 psi <i>0...1/0...10 bar</i>	0...0,4/0...10 bar
<b>Accuracy</b> <i>Classe di precisione</i>	1,6	1,6	1,6	2,5	1,6	1,6
<b>Protection degree</b> <i>Grado di protezione</i>	IP 55...67	IP 55...67	IP 55...67	IP 55...67	IP 55...67	IP 55...67
<b>Mounting</b> <i>Tipi di montaggio</i>						
<b>Main features</b> <i>Principali caratteristiche</i>	<ul style="list-style-type: none"> <li>• High static pressure 100 bar</li> <li>• ATEX constructional safety type "C"</li> <li>• Scale amplitude 180°</li> <li>• Pressione statica 100 bar</li> <li>• Sicurezza costruttiva ATEX tipo "C"</li> <li>• Ampiezza scala 180°</li> </ul>	<ul style="list-style-type: none"> <li>• Static pressure 25 bar</li> <li>• Scale amplitude 180°</li> <li>• Can be filled with dampening liquid</li> <li>• Electric contacts</li> <li>• Pressione statica 25 bar</li> <li>• Ampiezza scala 180°</li> <li>• Riempibile di liquido ammortizzante</li> <li>• Contatti elettrici</li> </ul>	<ul style="list-style-type: none"> <li>• ATEX constructional safety type "C"</li> <li>• Static pressure 200 bar</li> <li>• Can be filled with dampening liquid</li> <li>• Electric contacts</li> <li>• Sicurezza costruttiva ATEX tipo "C"</li> <li>• Pressione statica 200 bar</li> <li>• Riempibile di liquido ammortizzante</li> <li>• Contatti elettrici</li> </ul>	<ul style="list-style-type: none"> <li>• ATEX constructional safety type "C"</li> <li>• Static pressure 100 bar</li> <li>• Can be filled with dampening liquid</li> <li>• Electric contacts</li> <li>• Sicurezza costruttiva ATEX tipo "C"</li> <li>• Pressione statica 100 bar</li> <li>• Riempibile di liquido ammortizzante</li> <li>• Contatti elettrici</li> </ul>	<ul style="list-style-type: none"> <li>• ATEX constructional safety type "C"</li> <li>• Static pressure 400 bar</li> <li>• Can be filled with dampening liquid</li> <li>• Electric contacts</li> <li>• Sicurezza costruttiva ATEX tipo "C"</li> <li>• Pressione statica 400 bar</li> <li>• Riempibile di liquido ammortizzante</li> <li>• Contatti elettrici ammortizzante</li> </ul>	<ul style="list-style-type: none"> <li>• Available with AISI316 case and ring</li> <li>• Can be filled with dampening liquid</li> <li>• Disponibile con cassa ed anello in AISI316</li> <li>• Riempibile di liquido ammortizzante</li> </ul>





# Low-pressure gauges

# Manometri per basse pressioni

## PRESSURE GAUGES FOR ABSOLUTE PRESSURE

The pressure gauges for absolute pressure are used when the pressure to be measured must not be influenced by the variation of the atmospheric pressure. The fluid pressure to be measured is compared to a reference pressure that must be equal to absolute zero (absolute vacuum). In order to do this, the measuring element is isolated in a reference chamber, which is sealed and where absolute vacuum is created. According to the type of application, they are available with threaded or flanged connections and within the ranges from 0...60 mbar to 0...1 bar absolute. They are available in DS4" and DS6" and can be supplied with electric contacts.

## MANOMETRI PER PRESSIONE ASSOLUTA

I manometri per pressione assoluta sono utilizzati dove è richiesto che la pressione da misurare non sia influenzata dalla variazione della pressione atmosferica. La pressione del fluido da misurare è confrontata con una pressione di riferimento che deve essere uguale allo zero assoluto (vuoto assoluto). Per fare questo, l'elemento di misura è isolato in una camera di riferimento che viene sigillata e in cui viene creato il vuoto assoluto. Possono essere realizzati, in funzione del tipo di applicazione, con attacco filettato o flangiato e nei campi scala compresi da 0...60 mbar fino a 0...1 bar assoluti. Sono disponibili nel DN 100 e DN 150 e possono essere corredati con contatti elettrici.



MN12/18/ABS DS4"-6"  
MN12/18/ABS DN100-150



MN9/N DS4"  
MN9/N DN100



MN9/N DS2.5"  
MN9/N DN63



MN9/18 DS4"-6"  
MN9/18 DN100-150



MN12 DS4"-6"  
MN12 DN100-150

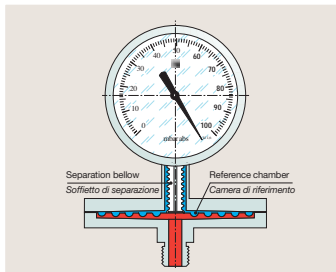

Operating diaphragm of the pressure gauge for absolute pressures MN12/18 ABS

Schema di funzionamento del manometro per pressioni assolute MN12/18 ABS.



Model - Modello	MN9/N DS2.5" MN9/N DN63	MN9/N DS4" MN9/N DN100	MN9/18 DS4"-6" MN9/18 DN100-150	MN12 DS4"-6" MN12 DN100-150	MN12/18/ABS DS4" MN12/18/ABS DN100
ATEX category Categoria ATEX				2GD	
Measuring element Principio di misura	capsule capsula	capsule capsula	capsule capsula	diaphragm membrana	diaphragm membrana
Ranges Campi scala	0...24/0...240 INWC and vacuum 0...60/0...600 mbar e vuoto	0...10/0...240 INWC and vacuum 0...25/0...600 mbar e vuoto	0...10/0...240 INWC and vacuum 0...25/0...600 mbar e vuoto	0...10 INWC/0...360 psi and vacuum 0...25 mbar/0...25 bar e vuoto	0...60/0...1000 mbar ABS
Accuracy Classe di precisione	1,6	1,6	1,6...1,0	1,6	1,6...1,0
Protection degree Grado di protezione	IP 55	IP 55	IP 55	IP 55...67	IP 65
Mounting Tipi di montaggio					
Main features Principali caratteristiche				<ul style="list-style-type: none"> <li>• Can be filled with dampening liquid for ranges <math>\geq 0,6</math> bar</li> <li>• Available with wetted parts in special material as: Hastelloy C, Hastelloy B, Monel 400, PTFE, etc.</li> <li>• Threaded and flanged process connections</li> <li>• ATEX constructional safety type "C"</li> <li>• Possibilità di riempimento di fluido ammortizzante per campi <math>\geq 0,6</math> bar</li> <li>• Disponibile con parti bagnate in materiali speciali quali: Hastelloy C, Hastelloy B, Monel 400, PTFE, ecc.</li> <li>• Attacchi al processo sia filettati che flangiati</li> <li>• Sicurezza costruttiva ATEX tipo "C"</li> </ul>	

# High-pressure gauges

# Manometri per alte pressioni

They are mainly used on high pressure water jet technology like water cutting machines, hydro blasting pumps and turbines, hydrodemolition. In case of leaks or break of the elastic element, the operator is protected by a solid separating wall placed on the front of the instrument and by the blow out back.

*Sono principalmente impiegati sulle apparecchiature che utilizzano la tecnologia "getto d'acqua" ad altissima pressione, quali taglio ad acqua, pompe e turbine per idropulitura, sistemi di idrodemolizione. In caso di perdite o rotture dell'elemento elastico, l'operatore risulta protetto da una solida parete posta verso il fronte dello strumento e dal fondo dirompente verso il retro.*



**MGS22 DS6"**  
MGS22 DN150



**MGS32 DS4.5"**  
MGS32 DN125



**MGS22 DS4"**  
MGS22 DN100



## SAFETY

The Solid-Front execution, in compliance with the "S3" safety methods of the EN837-1/2 standards, is provided with a solid wall placed in front of the pressure gauge and a blow out device in the back, which, in case of accidental leaks or rupture of the elastic element, protect the operator in the immediate surroundings.

## SICUREZZA

*L'esecuzione Solid-Front, in conformità a quanto prescritto dai criteri di sicurezza "S3" delle norme EN837-1/2, è dotata di una solida parete posta verso il fronte del manometro e un fondo dirompente verso il retro che, in caso di accidentali perdite o rotture dell'elemento elastico, proteggono l'operatore che si trova nelle immediate vicinanze.*



Model - Modello	MGS22 DS4"-6" MGS22 DN100-150	MGS32 DS4.5" MGS32 DN125
Wetted parts Materiale parti bagnate	duplex	duplex
Ranges Campi scala	0...30000/0...60000 psi 0...2500/0...4000 bar	0...30000/0...60000 psi 0...2500/0...4000 bar
Accuracy Classe di precisione	1 as per EN837 1 secondo EN837	1A grade as per ASME B40.1 grado 1A secondo ASME B40.1
Process connection Attacco al processo	M16 X 1,5 - 9/16-18 UNF	M16 X 1,5 - 9/16-18 UNF
Protection degree Grado di protezione	IP 55...67	IP 55...67
Mounting Tipi di montaggio		

## FLAME-PROOF PRESSURE SWITCHES

Should the dangerous air-gas mixture come in contact with the source of energy, the explosion produced would be "confined" inside the case, designed in such a way as to resist to the internal pressure, preventing in this way its propagation in the atmosphere surrounding the case. The Nuova Fima flame-proof pressure switches are produced in compliance with the EN 60079-0, EN 60079-1 standards, obtaining the Ex db IIC T6 Ex tb IIIC T85°C homologation issued by the CESI authorised laboratory of Milan.

## PRESSOSTATI ANTIDEFLAGRANTI

Nel caso in cui la miscela aria-gas pericolosa dovesse venire a contatto con la sorgente di energia, l'eventuale esplosione prodotta sarebbe "confinata" all'interno della custodia, progettata in modo tale da resistere alla pressione che verrebbe a svilupparsi, impedendo, quindi, la propagazione di questa all'atmosfera circostante la custodia stessa. I pressostati antideflagranti Nuova Fima, sono costruiti nel rispetto delle norme EN 60079-0/1, ottenendo l'omologazione Ex db IIC T6 Ex tb IIIC T85°C rilasciata dal laboratorio autorizzato CESI di Milano.



3.40



Compliance with the EN 60079-0, EN 60079-1 standards. Ex db IIC T6 Ex tb IIIC T85°C homologation issued by the CESI authorised laboratory of Milan.

Conformità a quanto prescritto dalle norme EN 60079-0, EN 60079-1. Omologazione Ex db IIC T6 Ex tb IIIC T85°C rilasciata dal laboratorio autorizzato CESI di Milano.



Declaration of conformity to the requirements of the Low Tension 73/23/EEC directive and further amendment 93/68/EEC.

Dichiarazione di conformità ai requisiti della direttiva di Bassa Tensione 73/23/CEE e successiva modifica 93/68/CEE.



3.20



3.27



3.10



3.25



3.30



3.28



3.48

Model - Modello	3.10	3.20	3.25	3.27
<b>Measuring element</b> <i>Principio di misura</i>	diaphragm <i>membrana</i>	diaphragm <i>membrana</i>	diaphragm <i>membrana</i>	diaphragm <i>membrana</i>
<b>Ranges</b> <i>Campi scala</i>	0...15/0...360 psi ...and vacuum <i>0...1/0...25 bar e vuoto</i>	0...15/0...360 psi <i>0...1/0...25 bar</i>	0...16 In WC/0...10 psi <i>0...40/0...600 mbar</i>	0...2,3 In WC/0...2300 psi ...and vacuum <i>0...6 mbar/0...160 bar e vuoto</i>
<b>Protection degree</b> <i>Grado di protezione</i>	IP 55	IP 55	IP 55	IP 65
<b>Electrical specifications</b> <i>Intervento elettrico</i>	N. 1 microswitch (SPDT) <i>N. 1 microinterruttore (SPDT)</i>	N. 1 microswitch (SPDT) <i>N. 1 microinterruttore (SPDT)</i>	N. 1 microswitch (SPDT) <i>N. 1 microinterruttore (SPDT)</i>	N. 1 o 2 microswitches (SPDT) <i>N. 1 o 2 microinterruttori (SPDT)</i>
<b>Process connection</b> <i>Attacco al processo</i>	threaded <i>filettato</i>	threaded <i>filettato</i>	threaded <i>filettato</i>	threaded or flanged <i>filettato o flangiato</i>
<b>Mounting</b> <i>Tipi di montaggio</i>				
<b>Main features</b> <i>Principali caratteristiche</i>	<ul style="list-style-type: none"> <li>• Low cost</li> <li>• Basso costo</li> </ul>	<ul style="list-style-type: none"> <li>• With fixed or adjustable differential microswitch</li> <li>• <i>Microinterruttore a differenziale fisso o regolabile</i></li> </ul>		<ul style="list-style-type: none"> <li>• With fixed or adjustable differential microswitch</li> <li>• Stainless steel case</li> <li>• <i>Microinterruttore a differenziale fisso o regolabile</i></li> <li>• <i>Custodia in acciaio inox</i></li> </ul>

Model - Modello	3.28 - 3.29	3.30	3.40 - 3.45	3.48 - 3.49
<b>ATEX category</b> <i>Categoria ATEX</i>			2GD	2GD
<b>Measuring element</b> <i>Principio di misura</i>	diaphragm <i>membrana</i>	bourdon tube <i>a molla Bourdon</i>	diaphragm <i>membrana</i>	diaphragm <i>membrana</i>
<b>Ranges</b> <i>Campi scala</i>	0...4/0...1500 psi <i>0...250 mbar/0...10 bar</i>	0...150/0...9000 psi <i>0...10/0...600 bar</i>	0...16 In WC/0...2300 psi ...and vacuum <i>0...40 mbar/0...160 bar e vuoto</i>	0...4/0...1500 psi <i>0...250 mbar/0...10 bar</i>
<b>Protection degree</b> <i>Grado di protezione</i>	IP 65	IP 55	IP 65	IP 65
<b>Electrical specifications</b> <i>Intervento elettrico</i>	N. 1 o 2 microswitches (SPDT) <i>N. 1 or 2 microinterruttori (SPDT)</i>	N. 1 o 2 microswitches (SPDT) <i>N. 1 or 2 microinterruttori (SPDT)</i>	N. 1 o 2 microswitches (SPDT) <i>N. 1 or 2 microinterruttori (SPDT)</i>	N. 1 o 2 microswitches (SPDT) <i>N. 1 or 2 microinterruttori (SPDT)</i>
<b>Process connection</b> <i>Attacco al processo</i>	threaded <i>filettato</i>	threaded <i>filettato</i>	threaded or flanged <i>filettato o flangiato</i>	threaded <i>filettato</i>
<b>Mounting</b> <i>Tipi di montaggio</i>				
<b>Main features</b> <i>Principali caratteristiche</i>	<ul style="list-style-type: none"> <li>• Differential pressure switch</li> <li>• With fixed or adjustable differential microswitch</li> <li>• Stainless steel case</li> <li>• <i>Pressostato differenziale</i></li> <li>• <i>Microinterruttore a differenziale fisso o regolabile</i></li> <li>• <i>Custodia in acciaio inox</i></li> </ul>	<ul style="list-style-type: none"> <li>• With fixed or adjustable differential microswitch</li> <li>• <i>Microinterruttore a differenziale fisso o regolabile</i></li> </ul>	<ul style="list-style-type: none"> <li>• Ex db IIC T6 Ex tb IIIC T85°C flame-proof execution</li> <li>• Available with flanged process connections</li> <li>• With fixed or adjustable differential microswitch</li> <li>• <i>Esecuzione antideflagrante Ex db IIC T6 Ex tb IIIC T85°C</i></li> <li>• <i>Disponibile con attacchi al processo flangiati</i></li> <li>• <i>Microinterruttore a differenziale fisso o regolabile</i></li> </ul>	<ul style="list-style-type: none"> <li>• Ex db IIC T6 Ex tb IIIC T85°C flame-proof execution</li> <li>• Differential pressure switch</li> <li>• With fixed or adjustable differential microswitch</li> <li>• Static pressure from 4 to 25 bar</li> <li>• <i>Esecuzione antideflagrante Ex db IIC T6 Ex tb IIIC T85°C</i></li> <li>• <i>Pressostato differenziale</i></li> <li>• <i>Microinterruttore a differenziale fisso o regolabile</i></li> <li>• <i>Pressione statica da 4 a 25 bar</i></li> </ul>



In order to isolate the measuring element of pressure gauges, pressure switches and electronic pressure transmitters from corrosive, viscous and sedimentary process fluids, it is necessary to place in between a diaphragm seal, which must often be made of special high-strength materials.

In order to control the costs deriving from the utilization of special materials, Nuova Fima has developed a new series of diaphragm seals with flanged connection, in which special alloys are used only for the parts in contact with the process fluid.

They are available with the following flanged connections:

- DS25...50 NP2.5...40 according to the UNI/DIN standards
- DS1/2"...2" NP150...600 according to ANSI B16.5

and with the following materials:

- AISI316 + PTFE
- Monel 400
- Hastelloy C276
- Hastelloy B2
- Tantalum
- Incolloy 825
- Inconel 600

*Per isolare l'elemento di misura di manometri, pressostati e trasmettitori elettronici di pressione, da fluidi di processo corrosivi, viscosi e sedimentosi, è necessario interporre un separatore di fluido che, spesso, deve essere realizzato in materiale speciale e pregiato. Per contenere i costi derivanti dall'utilizzo dei materiali speciali, Nuova Fima ha realizzato una nuova serie di separatori di fluido con attacco flangiato, in cui l'utilizzo delle leghe speciali è ridotto alle sole parti a contatto con il fluido di processo.*

*Sono disponibili con i seguenti attacchi flangiati:*

- DN25...50 PN2,5...40 secondo le norme UNI/DIN
- DN1/2"...2" PN150...600 secondo ANSI B16.5

*e con i seguenti materiali:*

- AISI316 + PTFE
- Monel 400
- Hastelloy C276
- Hastelloy B2
- Tantalio
- Incolloy 825
- Inconel 600



MGS9/4



MGS9/1B



MGS9/1AS



MGS9/1A0



MGS9/111



MGS9/2B



MGS9/7



MGS9/3A0



MGS9/3B0



MGS9/6



MGS9/5



MGS9/MINI/A



MGS9/P



MGS9/SA



MGS9/AL



MGS9/R



MGS9/367



The Nuova Fima diaphragm seals are produced also in versions to be mounted on electronic pressure transmitters, maintaining the accuracy and reliability features during all the operating conditions.

*I separatori di fluido Nuova Fima sono realizzati anche in versione adatta all'accoppiamento a trasmettitori elettronici di pressione, garantendo che le caratteristiche di precisione e affidabilità vengano mantenute in tutte le condizioni di esercizio.*



Nuova Fima uses hundreds of diaphragms in different shapes, dimensions and materials to cover all the different requirements. They are available also in a gold-plated version > 25 µm.

*Nuova Fima utilizza centinaia di membrane in diverse forme, dimensioni e materiali, per coprire tutte le esigenze della separazione. Sono disponibili anche in versione con doratura > 25 µm.*

Model - Modello	MGS9/1B0-1BS	MGS9/1A0-1AS	MGS9/111	MGS9/7	MGS9/3A0-3B0
<b>Ranges</b> <i>Campi scala</i>	0...40 INWC/0...4580 psi ...and vacuum 0...0,1/0...40 bar e vuoto	0...6000/0...8000 psi 0...400/0...600 bar	0...100/0...3000 psi 0...6/0...250 bar	0...15/0...2320 psi ...and vacuum 0...1/0...160 bar e vuoto	0...15/0...3000 psi ...and vacuum 0...1/0...250 bar e vuoto
<b>Wetted parts</b> <i>Materiale parti bagnate</i>	AISI316L and/or special materials AISI316L e/o materiali speciali	AISI316L	AISI316L	AISI316L and/or special materials AISI316L e/o materiali speciali	AISI316L and/or special materials AISI316L e/o materiali speciali
<b>Process connection</b> <i>Attacco al processo</i>	threaded filettato	threaded filettato	threaded filettato	flanged flangiato	flanged flangiato
<b>Mounting</b> <i>Tipi di montaggio</i>					
<b>Main features</b> <i>Principali caratteristiche</i>	<ul style="list-style-type: none"> <li>• Can be dismounted for cleaning</li> <li>• Smontabile per consentirne la pulizia</li> </ul>		<ul style="list-style-type: none"> <li>• Can be dismounted for cleaning</li> <li>• Smontabile per consentirne la pulizia</li> </ul>	<ul style="list-style-type: none"> <li>• Detachable for cleaning</li> <li>• "Continuous duty" execution</li> <li>• Smontabile per pulizia</li> <li>• Esecuzione "Continuous duty"</li> </ul>	<ul style="list-style-type: none"> <li>• Flanged connection with passing through holes</li> <li>• Available with PTFE coating</li> <li>• Attacco flangiato con fori passanti</li> <li>• Disponibile con rivestimento PTFE</li> </ul>

Model - Modello	MGS9/6	MGS9/5	MGS9/4	MGS9/MINI	MGS9/SA
<b>Ranges</b> <i>Campi scala</i>	0...15/0...600 psi ...and vacuum 0...1/0...40 bar e vuoto	0...15/1...6000 psi ...and vacuum 0...1/0...400 bar e vuoto	0...15/0...600 psi 0...1/0...40 bar	0...15/1...6000 psi ...and vacuum 0...0/1...400 bar e vuoto	0...15/0...600 psi 0...1/0...40 bar
<b>Wetted parts</b> <i>Materiale parti bagnate</i>	AISI316L and/or special materials AISI316L e/o materiali speciali	AISI316L and/or special materials AISI316L e/o materiali speciali	AISI316L and/or special materials AISI316L e/o materiali speciali	AISI316L	AISI316L
<b>Process connection</b> <i>Attacco al processo</i>	flanged flangiato	flanged flangiato	flanged flangiato	threaded filettato	DIN11581, SMS681, RJT/APV, IDF/ISS
<b>Mounting</b> <i>Tipi di montaggio</i>					
<b>Main features</b> <i>Principali caratteristiche</i>	<ul style="list-style-type: none"> <li>• Available with PTFE coating</li> <li>• Disponibile con rivestimento PTFE</li> </ul>	<ul style="list-style-type: none"> <li>• Flanged connection with passing through holes</li> <li>• Faced diaphragm</li> <li>• Attacco flangiato con fori passanti</li> <li>• Membrana affacciata</li> </ul>	<ul style="list-style-type: none"> <li>• Flanged connection with passing through holes</li> <li>• Faced diaphragm</li> <li>• Economic execution for special materials</li> <li>• Available with PTFE coating</li> <li>• Attacco flangiato con fori passanti</li> <li>• Membrana affacciata</li> <li>• Esecuzione economica per costruzione in materiale speciale</li> <li>• Disponibile con rivestimento PTFE</li> </ul>	<ul style="list-style-type: none"> <li>• Compact and economic model</li> <li>• Versione compatta ed economica</li> </ul>	<ul style="list-style-type: none"> <li>• Food industry process connection</li> <li>• Attacco per industria alimentare</li> </ul>

Model - Modello	MGS9/AL	MGS9/R	MGS9/367	MGS9/P	MGS9/2B
<b>Ranges</b> <i>Campi scala</i>	0...15/0...600 psi 0...1/0...40 bar	0...100/0...3000 psi 0...6/0...250 bar	0...600/0...6000 psi 0...40/0...400 bar	0...15/0...150 psi 0...1/0...10 bar	0...15/0...2320 psi, and vacuum 0...1/0...160 bar e vuoto
<b>Wetted parts</b> <i>Materiale parti bagnate</i>	AISI316L	AISI316L	AISI316L	PVC	AISI316L and/or special materials AISI316L e/o materiali speciali
<b>Process connection</b> <i>Attacco al processo</i>	ISO 2852	to be in-lined welded or flanged connections a saldare in linea o flangiato	threaded filettato	threaded filettato	threaded filettato
<b>Mounting</b> <i>Tipi di montaggio</i>					
<b>Main features</b> <i>Principali caratteristiche</i>	<ul style="list-style-type: none"> <li>• ISO 2852 connections 1"1/2; 2"; 2"1/2</li> <li>• Attacchi 1"1/2; 2"; 2"1/2</li> </ul>		<ul style="list-style-type: none"> <li>• Faced diaphragm with threaded connection</li> <li>• Membrana affacciata con attacco filettato</li> </ul>	<ul style="list-style-type: none"> <li>• All plastic material</li> <li>• Interamente in materiale plastico</li> </ul>	<ul style="list-style-type: none"> <li>• Detachable for cleaning</li> <li>• "Continuous duty" execution</li> <li>• Smontabile per pulizia</li> <li>• Esecuzione "Continuous duty"</li> </ul>

# Bar stock valves

# Valvole da barra

- Pressure gauges, pressure switches and transmitters
- Process, chemical and petrochemical industry
- AISI 316L st.st or special materials wetted parts
- Non-rotating needle
- Operating temperature: -54...+550°C
- Stem protected from system media
- St.st. stop pin

- Per manometri, pressostati e sensori
- Impiantistica generica, industria chimica e petrolchimica
- Parti bagnate in AISI 316L o materiali speciali
- Otturatore a tenuta non-rotante
- Campo di temperatura -54...+550°C
- Stelo protetto dai fluidi di processo
- Spina di sicurezza antiallentamento



BSM/M5F



BSM/M3A



BSM/M5B



BSV/VVM



BSV/VMM



BSM/M2

Model - Modello	BSV/VV-	BSV/VM-	BSM/M2	BSM/M3A	BSM/M5F	BSM/M5B
Type Tipo	Needle valve Valvola a spillo	Multiport needle valve Valvola a spillo, multiport	Two-valve manifold Manifold a 2 valvole	Three-valve manifold Manifold a 3 valvole	Five-valve manifold Manifold a 5 valvole	Five-valve manifold Manifold a 5 valvole
Rating	6000 psi, 10000 psi	6000 psi, 10000 psi	6000 psi, 10000 psi	6000 psi, 10000 psi	6000 psi, 10000 psi	6000 psi, 10000 psi
Wetted parts Materiale parti bagnate	AISI316L and/or special materials AISI316L e/o materiali speciali	AISI316L and/or special materials AISI316L e/o materiali speciali	AISI316L and/or special materials AISI316L e/o materiali speciali	AISI316L and/or special materials AISI316L e/o materiali speciali	AISI316L and/or special materials AISI316L e/o materiali speciali	AISI316L and/or special materials AISI316L e/o materiali speciali
Mounting Tipi di montaggio	Direct Direct	Direct Direct	Direct Direct	Direct Direct	Remote Remoto	Direct Direct
Main features Principali caratteristiche	• Block and bleed • Blocco e spurgo	• Block • Blocco	• Block and bleed • Blocco e spurgo	• Block and equalizer • Blocco ed equalizzazione	• Block, bleed and equalizer • Blocco, spurgo ed equalizzazione	• Block, bleed and equalizer • Blocco, spurgo ed equalizzazione



**MP3/34...36**  
 2/3-way forged valves and by-pass valves  
*Valvole forgiate a 2/3 vie e by-pass*



**7RC...7FL**  
 Piping welded connections  
 for MGS9/R diaphragm seal  
*Attacchi a saldare per  
 separatori MGS9/R*



**MP3/2...66**  
 Pig tails and siphons  
*Ricci e sifoni*



**MP4/8 - MP4/9**  
 Bellows and piston overload  
 protection device  
*Limitatori di pressione  
 a soffietto e a pistone*



**MP4/7 + MP4/5**  
 Needle dampeners  
 and porous dampeners  
*Smorzatori di pressione a  
 sezione variabile e a disco poroso*



## INERT GAS FILLED THERMOMETERS

Nuova Fima's inert gas thermometers can be used in every application due to the wide choice of ranges and mounting styles.

In case of accident, the inert gas used, nitrogen or helium, is not dangerous for the measuring process or for the environment. This is very important considering that every year a large quantity of products is damaged by substances like mercury, toluene, ethylene and Freon contained in temperature measuring instruments.

## TERMOMETRI A GAS INERTE

I termometri a gas inerte, prodotti dalla Nuova Fima, possono essere installati senza limitazione d'impiego grazie all'estesa gamma dei campi scala e dei tipi di montaggio.

Il gas inerte utilizzato, azoto od elio, non rappresenta alcun pericolo, in caso d'incidente, per il processo da misurare nonchè per l'ambiente. Questo è molto importante se si considera che ogni anno grandi quantità di prodotto sono danneggiate da sostanze come il mercurio, il toluene, l'etilene ed il freon contenuti in strumenti misuratori di temperatura.



TG85X DS4"  
TG85X DN100

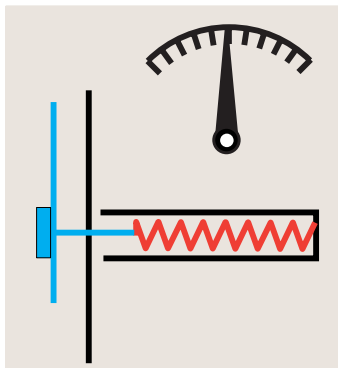

### BIMETALLIC THERMOMETERS OPERATING PRINCIPLE.

The bimetallic thermometers are made of a stainless steel pipe (bulb) containing a bimetallic helical spiral welded at one end to the bottom of the pipe and on the other to a small driving shaft connected to a pointer. Temperature variations deform the bimetal: this deformation is transmitted to the pointer on the dial due to the shaft rotation.

### TERMOMETRI BIMETALLICI. PRINCIPIO DI FUNZIONAMENTO.

I termometri bimetallici sono composti da un tubo in acciaio (bulbo) al cui interno è posta una spirale elicoidale bimetallica saldata ad un'estremità, alla parte inferiore del tubo e dall'altra, ad un alberino di trasmissione, a sua volta connesso ad una lancetta. Le variazioni di temperatura causano nel bimetallo una deformazione che, attraverso la rotazione dell'alberino, si trasmette alla lancetta ruotante sul quadrante.

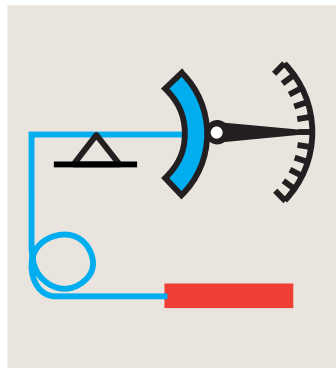

### INERT GAS THERMOMETERS OPERATING PRINCIPLE.

The measuring system is pressurised with inert gas in such a way that the change of temperature causes the variation of the pressure contained in the system, detected as a shifting and transmitted to the pointer through the movement. Ambient temperature variations, which can influence the accuracy, are compensated by means of a bimetal link placed inside the case.

### TERMOMETRI A GAS INERTE. PRINCIPIO DI FUNZIONAMENTO.

Il sistema di misura viene pressurizzato con gas inerte, in modo tale che il variare della temperatura provoca la variazione della pressione contenuta nel sistema stesso, rilevata sotto forma di spostamento e trasmessa all'indice attraverso il meccanismo. Le variazioni della temperatura ambiente, che possono influire sulla precisione, sono compensate per mezzo di un tirantino bimetallico posto all'interno della cassa.



TG89X DS4"  
TG89X DN100



TA819 DS4"  
TA819 DN100



TB74X DS3"  
TB74X DN80



TB99X DS4.5"  
TB99X DN125



TB89X DS4"-4.5"-6"  
TB89X DN100-125-150

Model - Modello	TB7 DS2.5"-3"-4"-4.5" TB7 DN63-80-100-125	TB8 DS4"-4.5"-6" TB8 DS100-125-150	TB9 DS4.5" TB9 DN125
ATEX category Categoria ATEX		2GD	
Measuring element Principio di misura	bimetal bimetallo	bimetal bimetallo	bimetal bimetallo
Wetted parts Materiale parti bagnate	AISI303 - AISI316	AISI316	AISI303
Ranges Campi scala	-20...+40/0...500°C	-80...+120/200...1200°F -50...+50/100...600°C	-80...+1000°F
Accuracy Classe di precisione	2,0 as per EN 13190 2,0 secondo EN 13190	1,0 as per EN 13190 1,0 secondo EN 13190	A grade as per ASME B40.3 grado A secondo ASME B40.3
Protection degree Grado di protezione	IP 55	IP 55...67	IP 67
Mounting Tipi di montaggio			
Main features Principali caratteristiche		<ul style="list-style-type: none"> <li>• Can be filled with dampening liquid</li> <li>• ATEX constructional safety type "C"</li> <li>• Possibilità di riempimento di fluido ammortizzante</li> <li>• Sicurezza costruttiva ATEX tipo "C"</li> </ul>	<ul style="list-style-type: none"> <li>• External zero adjustment</li> <li>• Azzeramento esterno</li> </ul>

Model - Modello	TG8 DS4"-6" TG8 DN100-150	TA819 DS4" TA819 DN100
ATEX category Categoria ATEX	2GD	
Measuring element Principio di misura	inert gas gas inerte	inert gas gas inerte
Wetted parts Materiale parti bagnate	AISI316	AISI316
Ranges Campi scala	-350...+200/200...1200°F -200...+100/100...600°C	0...+650°C/°F
Accuracy (as per EN 13190) Classe di precisione (secondo EN 13190)	1,0	1,0
Protection degree Grado di protezione	IP 55...67	IP 67
Mounting Tipi di montaggio		
Main features Principali caratteristiche	<ul style="list-style-type: none"> <li>• Can be filled with dampening liquid</li> <li>• Remote mounting with capillary</li> <li>• ATEX constructional safety type "C"</li> <li>• Possibilità di riempimento di fluido ammortizzante</li> <li>• Montaggio remoto con capillare</li> <li>• Sicurezza costruttiva ATEX tipo "C"</li> </ul>	<ul style="list-style-type: none"> <li>• Waste gas of diesel engines monitoring</li> <li>• Monitoraggio gas scarico motori diesel</li> </ul>

Thermowells are used to protect bulbs from the effects of corrosion and process fluid flow, due to the high speed at which the process fluid flows, and to enable the thermometer to be interchanged, recalibrated, or replaced, without disturbing the process. Different materials, flange dimensions and shank shape on customer demand, make the Nuova Fima thermowells suitable to any installation. All welding types can be made as simple, double, full penetration.

**Available material:**

- Monel 400
- Hastelloy C276
- Alloy 825
- Alloy 625
- Duplex SAF 2205
- Duplex SAF 2507

*I pozzetti termometrici vengono impiegati per proteggere il bulbo da effetti corrosivi, dalla pressione, dall'alta velocità del fluido di processo e per permettere l'intercambiabilità del termometro per la ricalibrazione o la sua sostituzione, senza disturbare il processo. Diversi materiali e dimensioni di flangia e forma del gambo a disegno cliente rendono i pozzetti NUOVA FIMA idonei a qualsiasi installazione. Tutti i tipi di saldatura possono essere realizzati: semplice, doppia, "full penetration".*

**Materiali disponibili:**

- Monel 400
- Hastelloy C276
- Alloy 825
- Alloy 625
- Duplex SAF 2205
- Duplex SAF 2507



W93



W92



W82



W10-20



W30-40



W50



W70

**Von Karman vortex**

When a thermowell is inserted into a process at a specific fluid speed it creates a turbulent wake (Von Karman Trail), which will have a particular frequency determined by the diameter of the thermowell and the speed of the process fluid. It is important for the thermowell dimensions to be chosen so that the frequency of the Karman wake is less than the resonant frequency of the thermowell. NUOVA FIMA make a deep analysis to check if the choosed thermowell is suitable for a safe installation.

**Vortici di Von Karman**

*L'installazione di un pozzetto in un fluido di processo avente una determinata velocità causa un'onda di turbolenza (VonKarman Trail) che ha una definita frequenza basata sul diametro del pozzetto e sulla velocità del fluido. E' importante che il pozzetto sia dimensionato correttamente cosicchè la frequenza dell'onda provocata sia inferiore alla frequenza di risonanza del pozzetto stesso. NUOVA FIMA in questo caso conduce un'adeguata analisi per la sicurezza dell'installazione.*

	Threaded thermowells <i>Pozzetti filettati</i>			Weld-in thermowell <i>Pozzetti a saldare</i>	Flanged thermowells <i>Pozzetti flangiati</i>		
	Built-up / Ricavati da tubo	Bar-stock / Ricavati da barra	Bar-stock / Ricavati da barra	Bar-stock / Ricavati da barra	Built-up / Ricavati da tubo	Bar-stock / Ricavati da barra	Bar-stock / Ricavati da barra
<b>Models - Modelli</b>	<b>W10-20</b>	<b>W30-40</b>	<b>W50</b>	<b>W70</b>	<b>W82</b>	<b>W92</b>	<b>W93</b>
<b>PN - psi (bar)</b>	360 (25)	1450 (100)	3600 (250)	1450 (100)...3600 (250)	360 (25)	1450 (100)	3600 (250)
<b>Immersion length Lunghezza immersione</b>	up to 196" max fino a 5000 mm	up to 40" max fino a 1000 mm	up to 40" max fino a 1000 mm	up to 40" max fino a 1000 mm	up to 196" max fino a 5000 mm	up to 40" max fino a 1000 mm	up to 40" max fino a 1000 mm
<b>Materials Materiali</b>	AISI316L	AISI316L and special materials <i>AISI316L e materiali speciali</i>	AISI316L and special materials <i>AISI316L e materiali speciali</i>	AISI316L and special materials <i>AISI316L e materiali speciali</i>	AISI316L	AISI316L and special materials <i>AISI316L e materiali speciali</i>	AISI316L and special materials <i>AISI316L e materiali speciali</i>
<b>Process connections Attacchi</b>	1/2"...1" Gas or NPT <i>1/2"...1" Gas o NPT</i>	1/2"...1" Gas or NPT <i>1/2"...1" Gas o NPT</i>	3/4"...1" Gas or NPT <i>3/4"...1" Gas o NPT</i>	to be welded <i>a saldare</i>	1/2"...2" DN15...50	3/4"...2" DN20...50	1"...2" DN25...50
<b>Internal hole diameter Diametro interno</b>	Ø 10-12 mm	Ø 7...12 mm	Ø 7...12 mm	Ø 7...12 mm	Ø 10...12 mm	Ø 7...12 mm	Ø 7...12 mm
<b>Main features Principali caratteristiche</b>			<ul style="list-style-type: none"> <li>• Von Karman analysis</li> <li>• <i>Analisi Von Karman</i></li> </ul>	<ul style="list-style-type: none"> <li>• Von Karman analysis</li> <li>• <i>Analisi Von Karman</i></li> </ul>			<ul style="list-style-type: none"> <li>• Von Karman analysis</li> <li>• <i>Analisi Von Karman</i></li> </ul>

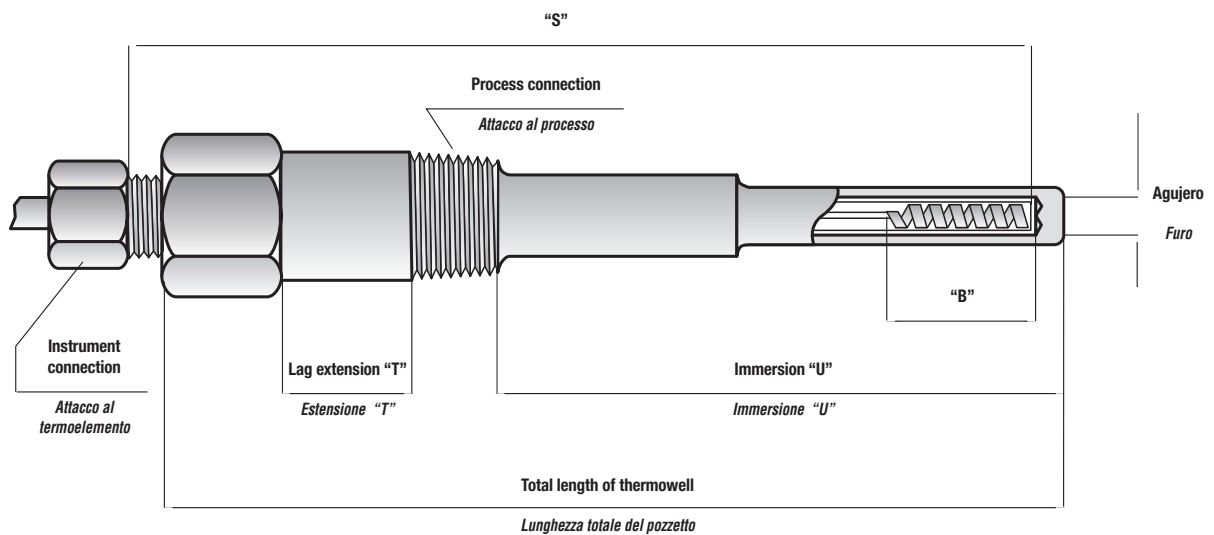



# Thermocouples and temperature resistance detector

# Termocoppie e termoresistenze

Thermocouples and Resistance Temperature Detectors are the most common sensors for the electric temperature measurement. They are suitable for temperature between -200 and +1800°C according to the measuring principle and the used materials. Moreover, they have remarkable advantages:

- sturdiness and vibration strength,
- fast response time,
- high accuracy.

Connectors and connection heads are available in various types and materials and they are suitable for all industrial applications. Thermocouples and RTD can be supplied in standard, intrinsically safe or explosion proof executions.

Le termocoppie e le termoresistenze sono i più comuni sensori per la misura della temperatura con metodo elettrico. A seconda del principio di funzionamento e dei materiali adottati, sono adatti per la misura di temperature comprese tra -200° e +1800°C.

- Presentano inoltre, notevoli vantaggi quali:
- robustezza e resistenza alle vibrazioni,
  - tempo di risposta rapido,
  - precisione elevata.

Sono disponibili connettori e teste di connessione in diversi materiali e versioni, adatte all'impiego in tutte le applicazioni industriali.

Le termocoppie e le termoresistenze possono essere fornite in esecuzione standard, sicurezza intrinseca e antideflagrante.



Ex d temperature assembly with explosion proof head  
Termoelemento, testa Ex d



A transmitter can be assembled inside the connection head to convert the electrical values generated by sensor into an analogue (4/20 mA) or digital signal output. Transmitters are available with a fixed, adjustable or programmable range (Smart) with HART™, PROFIBUS™ or FIELDBUS™ protocols.

Nella testa di connessione può essere montato un trasmettitore che converte proporzionalmente il valore generato dal sensore in un segnale di uscita analogico 4/20 mA o digitale. Sono disponibili trasmettitori a campo fisso, a campo selezionabile o a campo programmabile (smart) con protocollo HART™, PROFIBUS™ e FIELDBUS™.



Insert  
Inserto



Thermoelement with cable  
Termoelemento Miniatura



Model - Modello	Insert Inserto	Thermoelement Termoelemento	Standard assembly Esecuzione standard	Ex d assembly Esecuzione Ex d
RTD TC	• •	• •	•	• •
Type - Tipo	Pt100 / K, J, T, N, R, S, B	Pt100 / K, J, T, N, R, S	Pt100 / K, J, T, N, R, S, B	Pt100 / K, J, T, N, R, S, B
Ranges Campi di misura	-320...+3250°F -200...+1800°C	-320...+2900°F -200...+1600°C	-320...+3250°F -200...+1800°C	-320...+3250°F -200...+1800°C
Sheath diameter Diametro guaina	1,5...6,4 mm	2,5...12,7 mm	1,5...6,4 mm	1,5...6,4 mm
Insulation Isolamento	MgO / Ceramic MgO / Ceramica	MgO	MgO	MgO
Sheath material Materiale guaina	AISI316/Inconel 600/Ceramic	AISI316/Inconel 600	AISI316/Inconel 600	AISI316/Inconel 600
Protection degree Grado di protezione	IP 00	IP 00	IP 54...66	IP 54...66
Termination Terminazione	Ceramic terminal block Morsetteria ceramic	Cable Cavo	Aluminium or st. st. DIN B head Testa DIN B in alluminio o acciaio	Aluminium Ex d head Testa Ex d in alluminio
Mounting Tipi di montaggio				



Standard temperature assembly with light weight aluminium head  
Termoelemento, testa DIN B

**NUOVA FIMA**

NUOVA FIMA S.p.A.  
P.O. BOX 58 Via Cesare Battisti, 59  
28045 Inverio (NO) Italy  
Tel. +39 0322.253200  
Fax +39 0322.253232  
info@nuovafima.com

[www.nuovafima.com](http://www.nuovafima.com)