

Process Equipment

Pumping Solutions for Process Industries

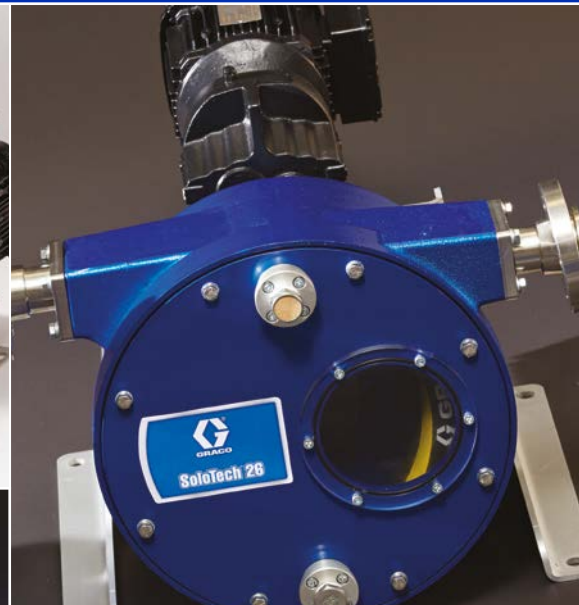

Which System is Right for You?

Pumping Solutions for Process Industries

Downtime is frustrating and costly. At Graco, we provide durable pumping solutions for your applications. Every pump is manufactured with your productivity in mind – providing you with a more reliable and efficient pump. Each pump is thoroughly tested before it leaves our factories.

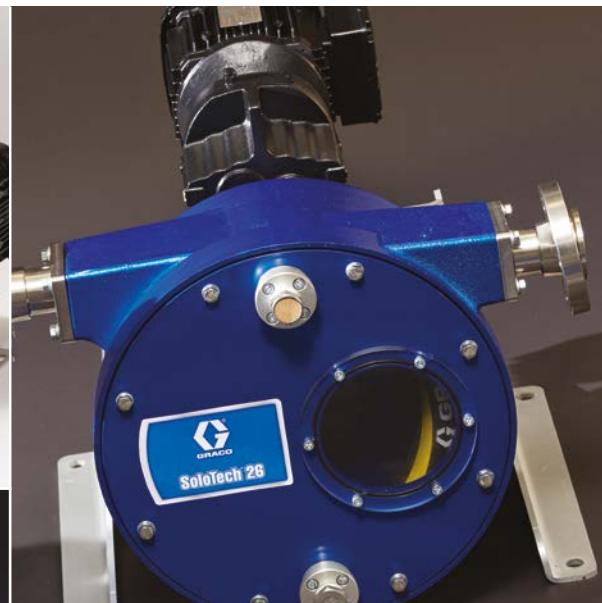

GRACO Process Selector Tools

Graco pump selectors are designed to make pump selection very easy.

Once you have selected a pump, the tool will provide you with ample information:

- the configuration
- major spare parts part numbers
- accessories

The pump selectors are available for the following products on each product page on the Graco website (www.graco.com).

A) Husky air-operated double diaphragm pumps:

B) Husky electric-operated double diaphragm pumps:

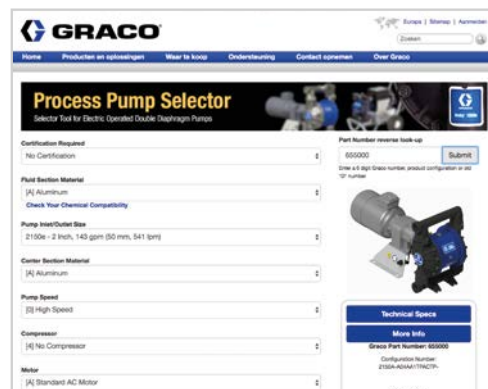
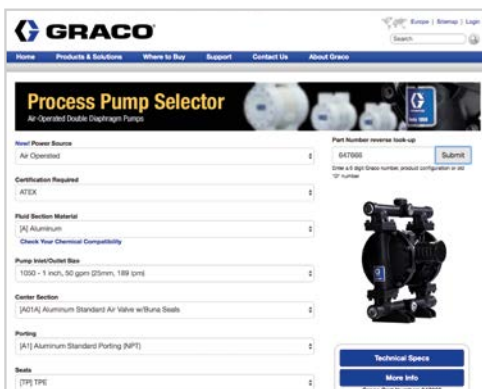

C) Piston pump selector tool:

D) Hose pump selector tool:

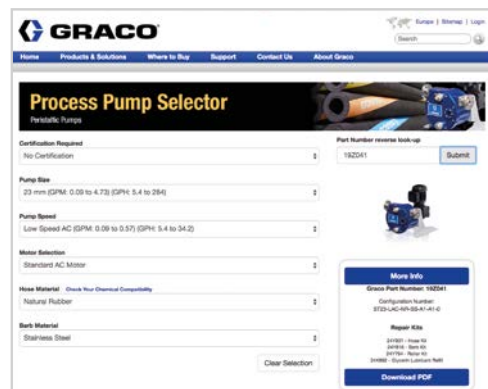
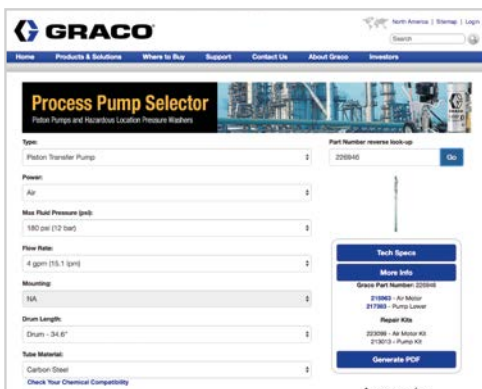

Air-Operated Double Diaphragm Pumps

Husky™ Transferring a Wide Range of Fluids

Our Husky air-operated double diaphragm pumps are loaded with features to help you get the job done right, every time, and are built to save you money.

Rugged construction

Resists corrosion for reliable performance and long life

Heavy-duty design - Offers long life, increased productivity and lower overall cost of ownership

Flow rates up to 1135 lpm (300 gpm)

Lube-free for cleaner operation

DataTrak™ available to prevent pump runaway and track material usage

Very easy & quick to repair!

Husky 3300

3 in (76.2 mm) connection
Max flow: 1135 lpm (300 gpm)
Polypropylene, aluminium,
stainless steel



Husky 2200

2 in (50.8 mm) connection
Max flow: 757 lpm (200 gpm)
Polypropylene, PVDF



Husky 2150

2 in (50.8 mm) connection
Max flow: 568 lpm (150 gpm)
Polypropylene, PVDF, aluminium,
stainless steel, iron



Husky 15120

1-1/2 in (38.1 mm) connection
Max flow: 454 lpm (120 gpm)
Polypropylene, PVDF



Husky 1590

1-1/2 in (38.1 mm) connection
Max flow: 340 lpm (90 gpm)
Polypropylene, PVDF, aluminium,
stainless steel



Husky 1050

1 in (25.4 mm) connection
Max flow: 189 lpm (50 gpm)
Aluminium, polypropylene, PVDF,
conductive polypropylene,
hastelloy, stainless steel

Air-Operated Double Diaphragm Pumps

The Husky Advantage

Loaded with Options

Choose from a wide selection of materials to handle numerous applications, including corrosive and abrasive fluid transfer.

Key fluids

- Paints, stains, coatings, inks and dyes
- Chemicals
- Acids
- Corrosive and abrasive fluids
- Lubricants
- Ceramic glazes
- Sludge, slurry and waste fluid
- Soaps, detergents and solvents
- General and advanced mining applications

Balls



Seats



Diaphragms



Husky 1050HP

1 in (25.4 mm) connection
Max flow: 189 lpm (50 gpm)
Aluminium and stainless steel



Husky 716

3/4 in (19.1 mm) connection
Max flow: 61 lpm (16 gpm)
Aluminium, stainless steel



Husky 515

1/2 in (12.7 mm) connection
Max flow: 57 lpm (15 gpm)
Polypropylene, acetal, PVDF



Husky 307

3/8 in (9.4 mm) connection
Max flow: 26 lpm (7 gpm)
Polypropylene, acetal



Husky 205

1/4 in (6.3 mm) connection
Max flow: 19 lpm (5 gpm)
Polypropylene, acetal, PVDF

Available construction materials and accessories may vary depending on pump model.

Electric Operated Double Diaphragm Pump

Graco's electric operated double diaphragm pumps are designed for **industrial, food, beverage and cosmetics** applications.

Why would you go for a GRACO electric operated double diaphragm pump?

- Can handle a wide variety of fluids thanks to many material options
- Can handle abrasive and corrosive materials
- Gentle on shear sensitive materials
- Can run dry
- Can stall under pressure -> closing a valve or clogging a line doesn't create issues
- Self priming (no need to fill the pump to operate)
- No rotating or moving fluid seals
- Compared to an Air-Operated Double Diaphragm pump
 - o Energy savings using an electric drive can save you up to 80% of energy costs versus an air-operated pump
 - o Less noise due to the use of an electric motor
 - o Low pulsation mode, so you don't need to purchase a pulsation dampener
 - o Same lifetime on diaphragms as an air-operated pump

Using Graco's electric diaphragm pump can lower your maintenance cost compared to using other technologies.

We can offer the advantages of an air-operated double diaphragm pump in an electric pump

Feature	Graco Electric Diaphragm Pumps	Other Electric Diaphragm Pumps	Air-Operated Diaphragm Pumps	Hose Pumps	Progressive Cavity Pumps	Rotary Lobe Pumps
Stalls under pressure	✓		✓			
Runs dry	✓	✓	✓	✓		
Self priming	✓	✓	✓	✓	✓	
No rotational shaft seal	✓	✓	✓	✓		
Low pulsation operation mode	✓				✓	✓

Stalls =

avoid damage due to pressure overload (like a closed valve)

Runs dry =

no damage when no fluid is pumped

Self priming =

no need to fill pump manually

No rotational shaft seal =

eliminate leaks and reduce maintenance costs

Low pulsation =

avoid buying a pulsation dampener



Graco's Unique Design Explained

To deliver the features you need, we use a Patent pending air charged drive

The pump is driven by a motor that moves a centre block sideways. By filling the centre block with air, the diaphragms are pushed out using this air. Mechanically, the centre block moves from left to right which means the air is pushing the diaphragms. We don't mechanically push the diaphragms.

We do **NOT** consume air, we only use air to charge the centre.

Durable Pump Technology

- Handles slurries and abrasives all without damage to the pump
- Gentle on shear sensitive material

Diaphragm Pump

- Runs dry
- No rotating or moving fluid seals
- Self priming

Electric Drive

- Reduce energy consumption and operating costs
- Increase pump control
- Accurately meter fluid

Fluid Section

- Create the pump you need with multiple material offerings for manifolds, seats, balls, and diaphragms

Patent Pending Air Charged Drive

- Increase diaphragm life without compromising your fluid - no hydraulic charge, so no risk of contamination
- Ability to reduce pulsation on fluid outlet
- Stalls under pressure without additional switches and controls

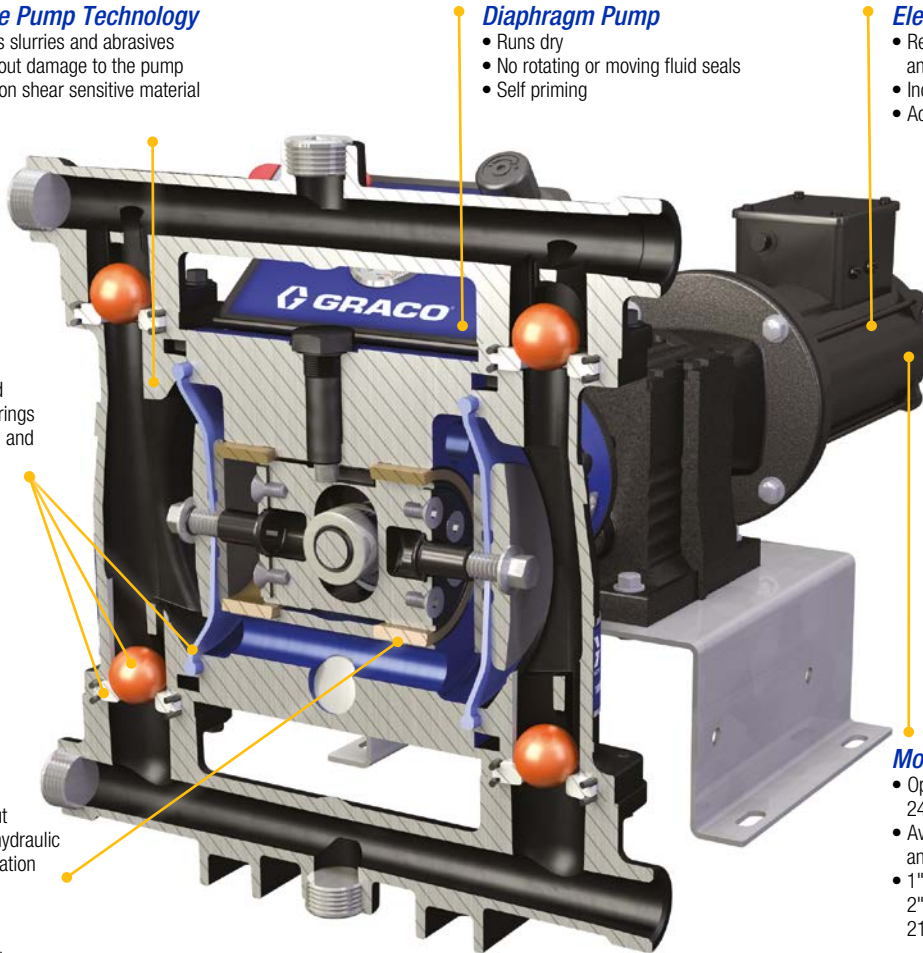

Motor Options

- Operate on 120V (only 1"), 240V or 480V power
- Available in AC, DC (only 1") and AC ATEX
- 1": one gearbox
- 2": 3 gearbox options: 130, 215 & 330 lpm

Pulsation Chart

Husky e-Series
(in low pulse mode)
AODD
Peristaltic

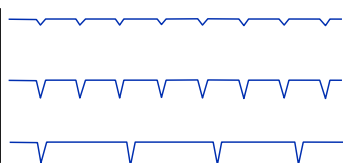

Need low pulsation? No Problem!

Another effect of our air charged drive is we can work in a "low-pulsation" mode eliminating the need for pulsation dampeners -> ideal when products are shear-sensitive, can foam, or require a smooth flow. In addition, our diaphragms are supported by air, so there is no hydraulic backing and therefore no risk of contamination.

How much can you save?

Enter your parameters into the Husky Electric Pump ROI Calculator to compare your costs with a traditional air-operated diaphragm pump.

To calculate your ROI, go to the online product pages to find the link to our calculator.

Example of ROI Tool

Air-Operated Double Diaphragm Pumps

ChemSafe™ Chemical Pumps

Our ChemSafe pumps are available with 100% PTFE or UHMWPE corrosion- and abrasion-resistant fluid paths, making them ideal for even the most challenging fluids. They also have no exposed metals and can be configured with various materials to meet the majority of abrasion, temperature and chemical compatibility requirements.

Leak-free design

- Dual force, tie-bolt design ensures chemical containment
- Precision fit, CNC-machined design

Corrosion-resistance

- 100% PTFE and UHMWPE fluid paths
- No exposed metals

Parallel pilot shifting

- Easy to maintain
- Stall-free design
- Reduced icing air system

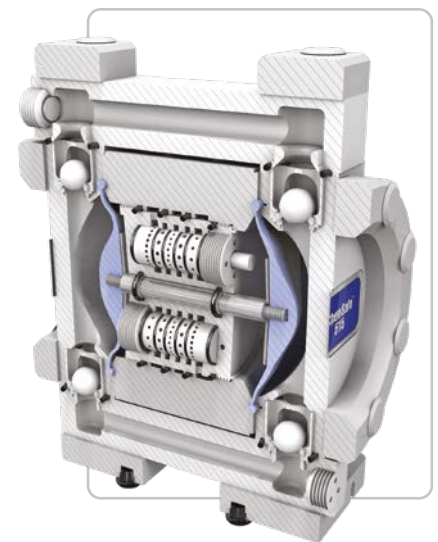

ChemSafe Models: 515, 1040, 1590



ChemSafe Models: 205, 307



ChemSafe1590
1-1/2 in (38.1 mm)
376 lpm (99.5 gpm)



ChemSafe 1040
1 in (25.4 mm)
146 lpm (38.8 gpm)



ChemSafe 515
1/2 in (12.7 mm)
60.6 lpm (16 gpm)



ChemSafe 307
3/8 in (9.4 mm)
25 lpm (6.7 gpm)



ChemSafe 205
1/4 in (6.3 mm)
14 lpm (3.7 gpm)

Hose Pumps

SoloTech™ Peristaltic Hose Pumps

With only the hose in contact with the fluid being pumped and no check valves in the line, Graco's SoloTech peristaltic pumps are ideal for materials that other pumps cannot handle. Abrasive, corrosive, shear-sensitive, and gas-entrapped fluids can easily be pumped or administered to your application.

- **Efficient pumping action** - One hose compression per revolution extends hose life
- **Low maintenance** - No valves, seals or glands
- **Reversible** - Pumps can be used to empty lines or clear blockages
- **Extended hose life** - Only one hose compression per revolution

Our BLDC motor/gearbox can handle a very large flow rate range, avoiding the need for different gearboxes for multiple applications.

Hose Design



Hose Materials	Stripe Colour / Inside Colour	Max. Fluid Temperature	Application Area
Natural Rubber (NR)	None / Black	71°C (160°F)	Abrasives
Chlorosulfonated polyethylene (CSM)	Orange / Black	121°C (250°F)	Highly corrosive chemicals
Nitrile	Yellow / Black	104°C (220°F)	Oils or oily products
Ethylene propylene (EPDM)	Blue / Black	121°C (250°F)	Corrosive chemicals



SoloTech 10
Max flow rate of 1.5 lpm (0.67 gpm).
Typically used for chemical metering applications.



SoloTech 23
Max flow rate of 17 lpm (4.5 gpm).
Typically used for chemical metering applications.



SoloTech 26
Max flow rate of 37.1 lpm (9.8 gpm).
Typically used for abrasive material transfer applications.



SoloTech 30
Max flow rate of 59.8 lpm (15.8 gpm).
Typically used for abrasive material transfer applications

High-Pressure Cleaning

Hydra-Clean™ High-Pressure Cleaning

Graco pneumatic-driven and hydraulic-driven Hydra-Clean heavy-duty pressure washers are perfect for use in a variety of in-plant cleaning applications and can be used with hot or cold water, detergents or strong chemical solutions up to 93°C (200°F). Available in wall-mount and cart-mount options.

- [ATEX certified](#)
- [300 Series stainless steel lower](#) – Compatible with many extreme chemicals and ideal for use with open-head drums
- [Supports multiple guns](#)
- [Five different spray tips](#) – Standard
- [Optional hose reel](#) – Easy hose storage



[Pneumatic Hydra-Clean](#)



[Hydraulic Hydra-Clean](#)



Transfer Pumps

Husky Transfer Pumps

Easily pump from a 205-litre drum with flow rates up to 61 lpm (16 gpm). Available in aluminium, carbon steel, stainless steel and polypropylene.

- **Suction tube** immersed inside the drum
- **Quick-priming** and immediate product flow
- **Fluid viscosities up to 5,000 cps** and solids up to 2.5 mm (0.094 in)
- **Air-tight seal** for moisture-sensitive fluids
- **Bung adapter** fits into any 2 in (50.8 mm) bung opening



Fast-Flo™ 1:1

Deliver a smooth, reliable flow. Drum length and stubby models are available in either carbon steel or stainless steel materials of construction. Ideal for a variety of non-corrosive and corrosive materials.

- **Flow rates** up to 15.1 lpm (4 gpm)
- **Immersed inlet** for faster priming of heavier fluids
- **Air-powered** for high reliability and low cost
- **Disc check** options for lower viscosity fluids



Ink Pumps

Pneumatic and hydraulic ink pumps with enclosed, dual-seal wet cup design with an extended seal life - ideal for the most difficult inks.

- **Prolong seal life** with enclosed, dual-seal wet cup
- **Runaway control** with optional DataTrak™
- **MaxLife™** seal for longer life
- **Handles difficult inks**, like letterpress and lithographic





ABOUT GRACO

Founded in 1926, Graco is a world leader in fluid handling systems and components. Graco products move, measure, control, dispense and apply a wide range of fluids and viscous materials used in vehicle lubrication, commercial and industrial settings.

The company's success is based on its unwavering commitment to technical excellence, world-class manufacturing and unparalleled customer service. Working closely with qualified distributors, Graco offers systems, products and technology that set the quality standard in a wide range of fluid handling solutions. Graco provides equipment for spray finishing, protective coating, paint circulation, lubrication, and dispensing sealants and adhesives, along with power application equipment for the contractor industry. Graco's ongoing investment in fluid management and control will continue to provide innovative solutions to a diverse global market.

GRACO LOCATIONS

MAILING ADDRESS

P.O. Box 1441
Minneapolis, MN 55440-1441
Tel: 612-623-6000
Fax: 612-623-6777

AMERICAS

MINNESOTA
Worldwide Headquarters
Graco Inc.
88-11th Avenue N.E.
Minneapolis, MN 55413

EUROPE

BELGIUM
European Distribution Center
Graco Distribution BV
Industrieterrein-Oude Bunders
Slakweidestraat 31
3630 Maasmechelen,
Belgium
Tel: 32 89 770 700
Fax: 32 89 770 777

ASIA PACIFIC

AUSTRALIA
Graco Australia Pty Ltd.
Suite 17, 2 Enterprise Drive
Bundoora, Victoria 3083
Australia
Tel: 61 3 9468 8500
Fax: 61 3 9468 8599

CHINA

Graco Fluid Equipment
(Shanghai) Co., Ltd
Building 7, No. 1-2,
Wenshui Road 299
Jing'an District
Shanghai 200436
P.R. China
Tel: 86 512 6260 5711
Fax: 86 21 6495 0077

INDIA

Graco Hong Kong Ltd.
India Liaison Office
Room 432, Augusta Point
Regus Business Centre 53
Golf Course Road
Gurgaon, Haryana
India 122001
Tel: 91 124 435 4208
Fax: 91 124 435 4001

JAPAN

Graco K.K.
1-27-12 Hayabuchi
Tsuzuki-ku,
Yokohama 224-0025,
Japan
Tel: 81 45 593 7300
Fax: 81 45 593 7301

KOREA

Graco Korea Inc.
38, Samsung 1-ro 1-gil
Hwaseong-si,
Gyeonggi-do, 18449
Republic of Korea
Tel: 82 31 8015 0961
Fax: 82 31 613 9801

All written and visual data contained in this document are based on the latest product information available at the time of publication. Graco reserves the right to make changes at any time without notice.

Graco is certified ISO 9001.

Represented by:



Zimco Instrumentation Inc.
11141 15 Street NE, Calgary, AB, T3K 0Z5, Canada
Phone: 403-253-8320
Email: info@zimco.ca
Website: www.zimco.ca

Europe
+32 89 770 700
FAX +32 89 770 777
WWW.GRACO.COM

©2018 Graco Distribution BV 300570ENEU Rev.L 09/21 Printed in Europe.
All other brand names or marks are used for identification purposes and are trademarks of their respective owners.
For more information on Graco's intellectual property, see www.graco.com/patent or www.graco.com/trademarks.